



BY APPOINTMENT TO HM QUEEN ELIZABETH II
WINDSOR GLASS COMPANY LTD
GLASS MERCHANTS
ESTABLISHED 1952

WINDSOR
GLASS



LOCKSETS AND HINGES

T 01753 862224

W WINDSORGLASS.COM

A WINDSOR GLASS CO LTD, UNIT 8, VANSITTART ESTATE, WINDSOR, BERKSHIRE, SL4 1SE



J'CSL-2367-03/16



Serrures et paumelles
Locksets and hinges

ASSA ABLOY

Serrures et
paumelles
Locksets and
hinges

Serrures *Locksets*

Lagune

Caractéristiques techniques générales

- Montage sur encoche 64A
- Réversible
- À cylindre européen panneton DIN (norme DIN 18254)
- Rappel du pêne à la clé
- Pour porte en verre trempé de 8 et 10 mm
- Condamnation par clé avec avancement du pêne
- Possibilités de combinaison avec passe général
- Livrée avec gâche plate et 3 clés

General technical features

- To fit notch 64A
- Reversible
- European profile cylinder (DIN standard 18254)
- Return of latch bolt by key
- For toughened glass doors 8-10 mm thick
- Locked by key with forward motion of latch bolt
- Possibility of combinations with master key
- Supplied with flat keep and 3 keys



4300

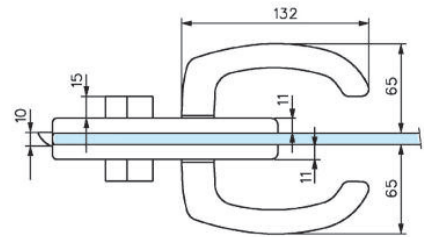
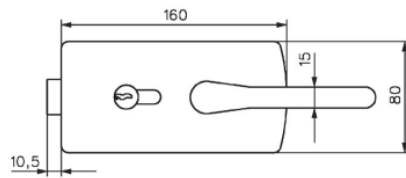
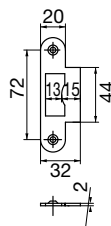
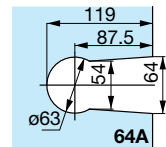

Références / References

Serrure de milieu à cylindre et double béquilles
Lock with euro profile cylinder and pair of handles



Chromé brillant
Bright chromium



Chromé mat
Matt chromium

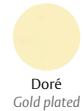

Doré
Gold plated



Laqué blanc 9010
Lacquered white RAL 9010

4300.30.0

4300.31.0

4300.40.0

4300.51.0



4309.**.0

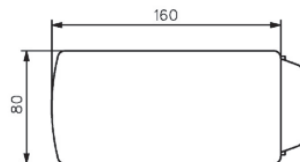
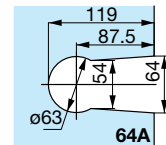

Références / References

Boîtier gâche pour serrures
séries 4300
Matching patch keep for locks series
4300-4310-4350



Chromé brillant
Bright chromium



Chromé mat
Matt chromium



Doré
Gold plated



Laqué blanc 9010
Lacquered white RAL 9010

4309.30.0

4309.31.0

4309.40.0

4309.51.0



40

ASSA ABLOY

0309



Gâche équerre pour serrures séries 4300-4310
Keep plate with stop for locks series 4300-4310



Chromé brillant
Bright chromium



Chromé mat
Matt chromium

0309.30.0

0309.31.0

4306

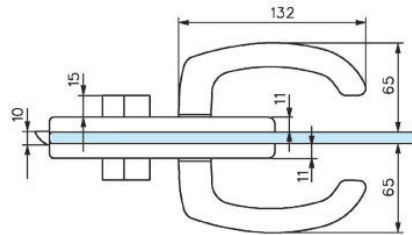
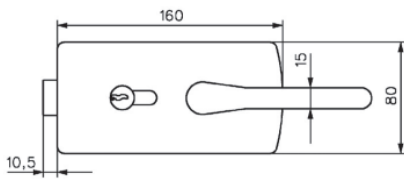
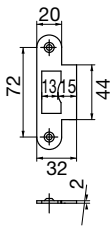
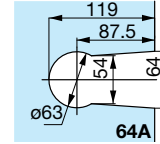

Références / References



Serrure de milieu à cylindre et béquilles condamnation sans avancement du pêne
Lock with euro profile cylinder and double handles, without forward motion of latch bolt



Chromé brillant
Bright chromium



Chromé mat
Matt chromium

4306.30.0

4306.31.0

4301

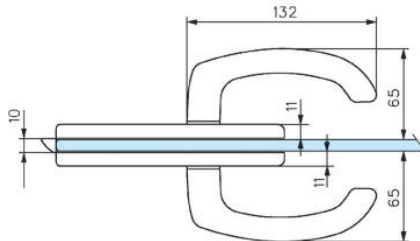
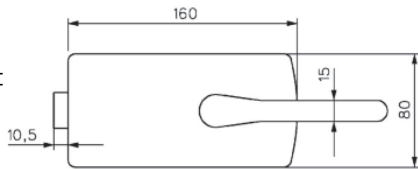
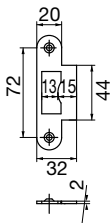
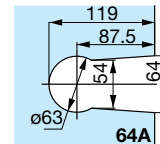

Références / References



Serrure de milieu bec de cane et double béquilles
Latch set with pair of handles



Chromé brillant
Bright chromium



Chromé mat
Matt chromium



Doré
Gold plated



Laqué blanc 9010
Lacquered white RAL 9010

4301.30.0

4301.31.0

4301.40.0

4301.51.0

Serrures et paumelles
Locksets and hinges

4307

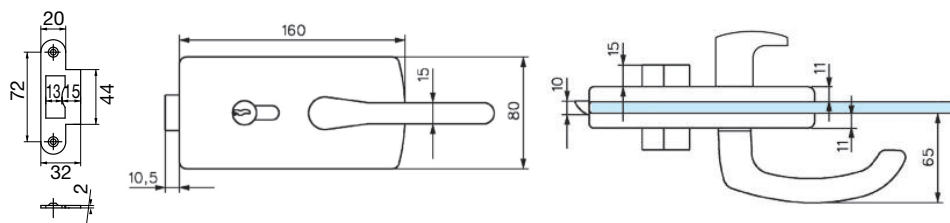
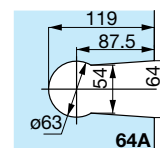

Références / References



Chromé brillant
Bright chromium



Chromé mat
Matt chromium

Serrure de milieu à cylindre avec béquille intérieure et bouton fixe extérieur, condamnation sans avancement du pêne
Lock with euro profile cylinder, lever handle inside and fixed knob outside, without forward motion of latch bolt

4307.30.0

4307.31.0

4310

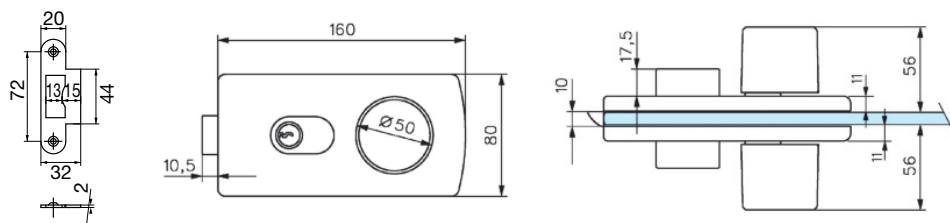
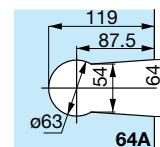

Références / References



Chromé brillant
Bright chromium



Chromé mat
Matt chromium



Doré
Gold plated

Serrure de milieu à cylindre et boutons de manoeuvre avec caches cylindre
Lock with euro profile cylinder and pair of knobs with cylinder covers

4310.30.0

4310.31.0

4310.40.0

4311

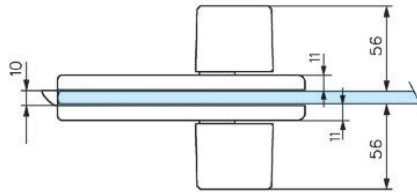
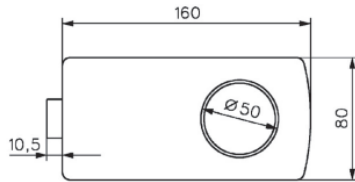
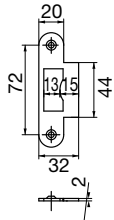
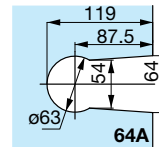

Références / References



Serrure de milieu bec de cane et boutons de manoeuvre
Latch lock with pair of knobs

4311.30.0

4311.31.0

4311.40.0

4312

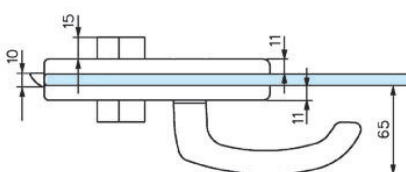
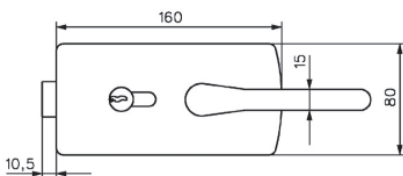
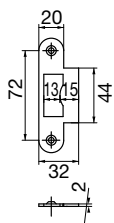
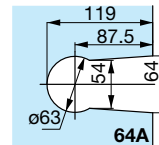

Références / References



Serrure de milieu à cylindre avec une seule béquille intérieure
Lock with euro profile cylinder and lever handle inside only

4312.30.0

4312.31.0

Serrures et paumelles
Locksets and hinges

4360

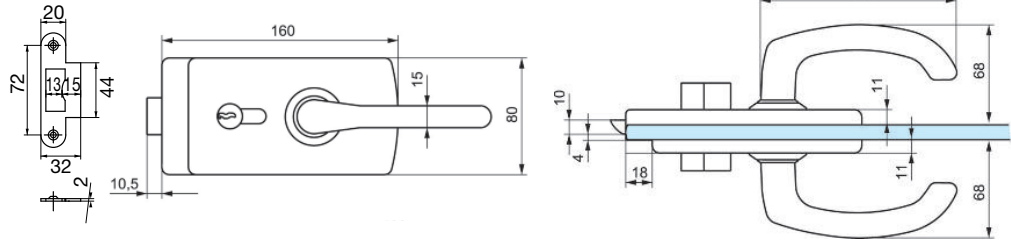
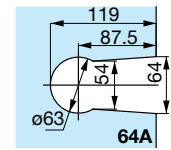

Références / References

Serrure de milieu à cylindre et béquilles
avec déport, pêne axé
Lock with euro profile cylinder,
handles and offset mechanism



Chromé brillant
Bright chromium



Chromé mat
Matt chromium



Doré
Gold plated



Laqué blanc 9010
Lacquered white RAL 9010



4360.30.0

4360.31.0

4360.40.0

4360.51.0



4360.30.4

4360.31.4

• Le mécanisme déporté permet un contact de la porte en fond de feuillure, et assure la continuité du joint au niveau de la serrure.

• Offset mechanism to allow compression of rebate strip.

4361

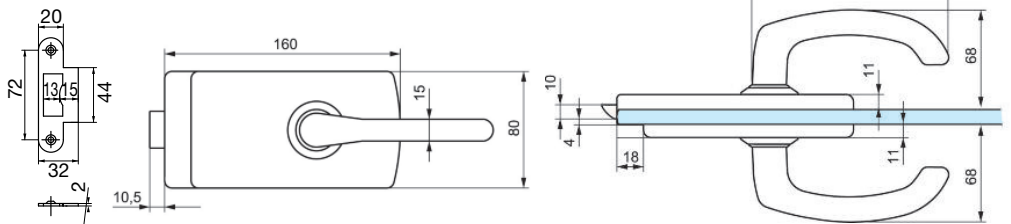
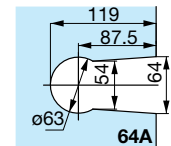

Références / References

Serrure de milieu bec de cane et béquilles
avec déport, pêne axé
Latch set with handles and offset mechanism



Chromé brillant
Bright chromium



Chromé mat
Matt chromium



Doré
Gold plated



Laqué blanc 9010
Lacquered white RAL 9010



4361.30.0

4361.31.0

4361.40.0

4361.51.0



4361.30.4

4361.31.4

• Le mécanisme déporté permet un contact de la porte en fond de feuillure, et assure la continuité du joint au niveau de la serrure.

• Offset mechanism to allow compression of rebate strip.

4360.0BT

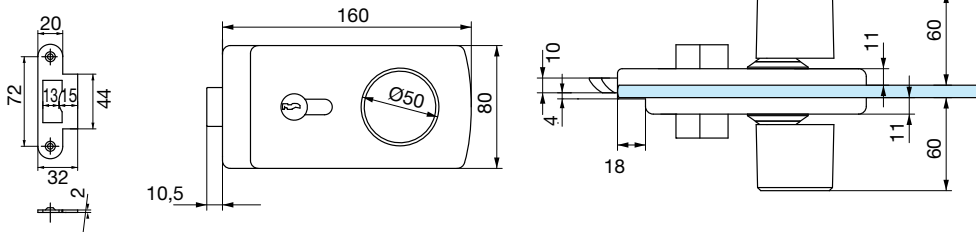
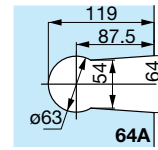

Références / References



Chromé brillant
Bright chromium



Chromé mat
Matt chromium



Laqué blanc 9010
Lacquered white RAL 9010

Serrure de milieu à cylindre et boutons de manoeuvre avec déport, pêne axé
Lock with euro profile cylinder with pair of knobs and offset mechanism

4360.30.0BT

4360.31.0BT

4360.51.0BT

- Le mécanisme déporté permet un contact de la porte en fond de feuillure, et assure la continuité du joint au niveau de la serrure.

- Offset mechanism to allow compression of rebate strip.

4361.0BT

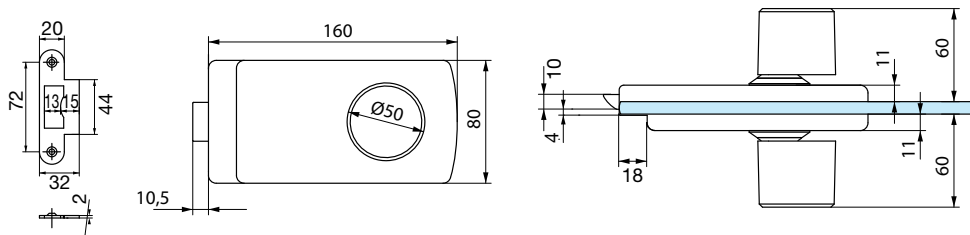
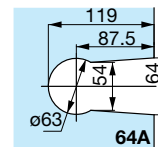

Références / References



Chromé brillant
Bright chromium



Chromé mat
Matt chromium



Laqué blanc 9010
Lacquered white RAL 9010

Serrure de milieu bec de cane avec déport et 2 boutons de manoeuvre
Latch set with knobs and offset mechanism

4361.30.0BT

4361.31.0BT

4361.51.0BT

- Le mécanisme déporté permet un contact de la porte en fond de feuillure, et assure la continuité du joint au niveau de la serrure.

- Offset mechanism to allow compression of rebate strip.

Serrures et paumelles
Locksets and hinges

4363.0E*T

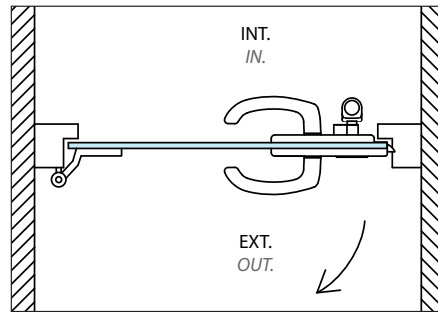
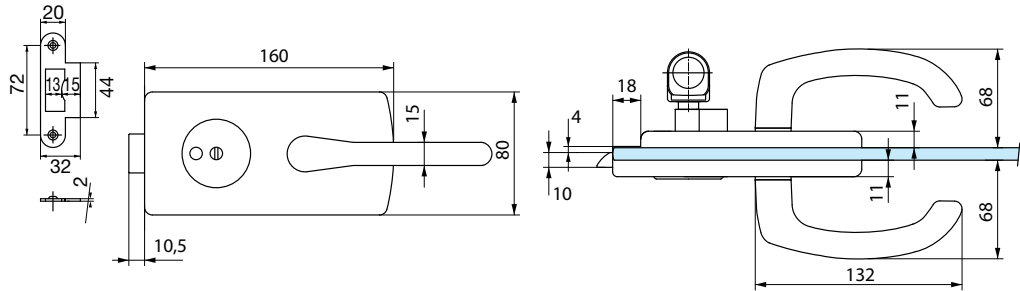
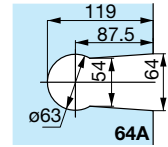

LES + PRODUITS

Mécanisme déporté

Idéal pour cabine et vestiaire

Sécurité : décondamnation d'urgence

Offset mechanism

Ideal for toilets and cloakrooms

Security : emergency exit

Références / References



Serrure avec voyant ouverture extérieure droite tirant
Lock with colour indicator outside opening right pull



Chromé brillant
Bright chromium



Chromé mat
Matt chromium

4363.30.0EDT

4363.31.0EDT

• Le mécanisme déporté permet un contact de la porte en fond de feuillure, et assure la continuité du joint au niveau de la serrure.

• Offset mechanism to allow compression of rebate strip.

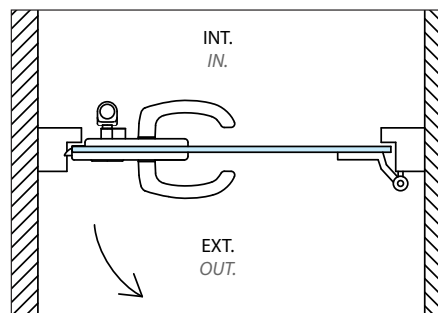

Références / References



Serrure avec voyant ouverture extérieure gauche tirant
Lock with colour indicator outside opening left pull



Chromé brillant
Bright chromium



Chromé mat
Matt chromium

4363.30.0EGT

4363.31.0EGT

• Le mécanisme déporté permet un contact de la porte en fond de feuillure, et assure la continuité du joint au niveau de la serrure.

• Offset mechanism to allow compression of rebate strip.

4363.01*P

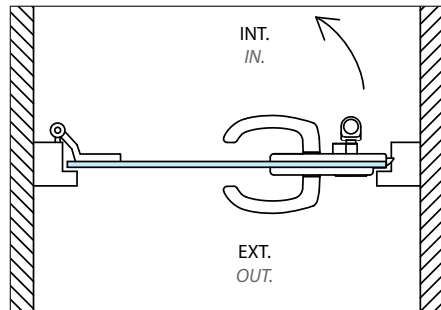
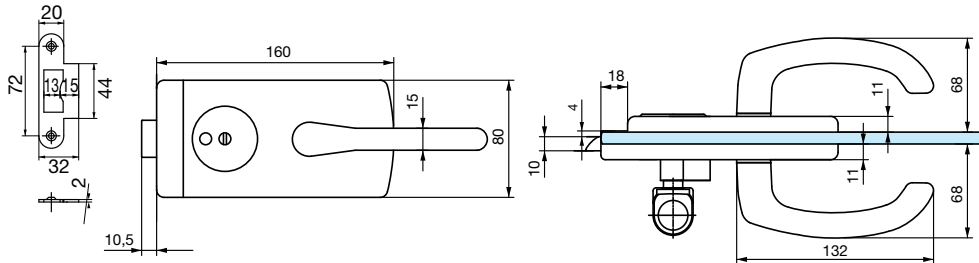
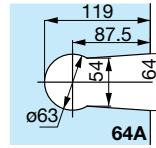

Références / References



Serrure avec voyant ouverture intérieure droite poussant
Lock with colour indicator inside opening right push



Chromé brillant
Bright chromium



Chromé mat
Matt chromium

4363.30.0IDP 4363.31.0IDP

- Le mécanisme déporté permet un contact de la porte en fond de feuillure, et assure la continuité du joint au niveau de la serrure.

- Offset mechanism to allow compression of rebate strip.

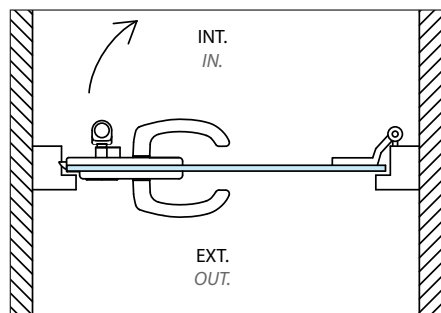

Références / References



Serrure avec voyant ouverture intérieure gauche poussant
Lock with colour indicator inside opening left push



Chromé brillant
Bright chromium



Chromé mat
Matt chromium

4363.30.0IGP 4363.31.0IGP

- Le mécanisme déporté permet un contact de la porte en fond de feuillure, et assure la continuité du joint au niveau de la serrure.

- Offset mechanism to allow compression of rebate strip.

Serrures et paumelles
Locksets and hinges

Serrures et paumelles
Locksets and hinges

4367.0**

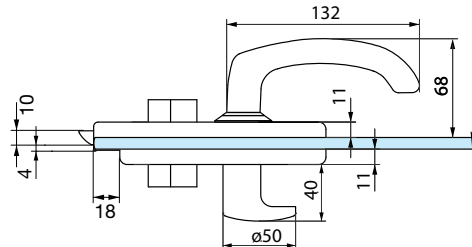
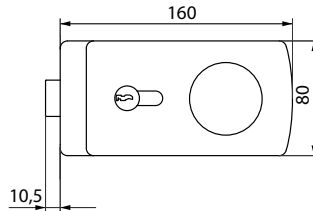
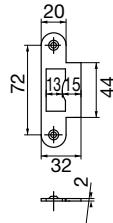
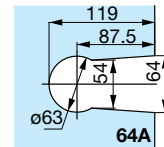

LES + PRODUITS

Mécanisme déporté

Offset mechanism

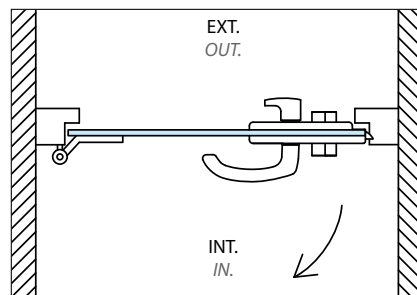

Références / References



Chromé brillant
Bright chromium



Chromé mat
Matt chromium

4367.30.0AD

4367.31.0AD

Serrure de milieu à cylindre et déport avec béquille intérieure et bouton fixe extérieur, condamnation sans avancement du pêne
Lock with euro profile cylinder and offset with handle inside fixed knob outside, without forward latch bolt motion

• Le mécanisme déporté permet un contact de la porte en fond de feuillure, et assure la continuité du joint au niveau de la serrure.

• Offset mechanism to allow compression of rebate strip.

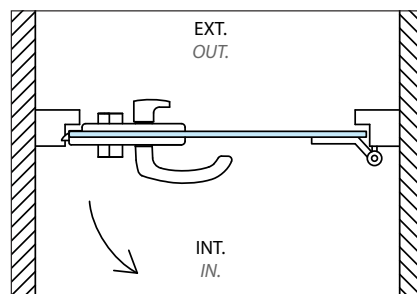

Références / References



Chromé brillant
Bright chromium



Chromé mat
Matt chromium

4367.30.0BC

4367.31.0BC

Serrure de milieu à cylindre et déport avec béquille intérieure et bouton fixe extérieur, condamnation sans avancement du pêne
Lock with euro profile cylinder and offset with handle inside fixed knob outside, without forward latch bolt motion

• Le mécanisme déporté permet un contact de la porte en fond de feuillure, et assure la continuité du joint au niveau de la serrure.

• Offset mechanism to allow compression of rebate strip.

4366

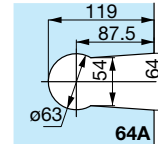

Serrures et
paumelles
Locksets and
hinges

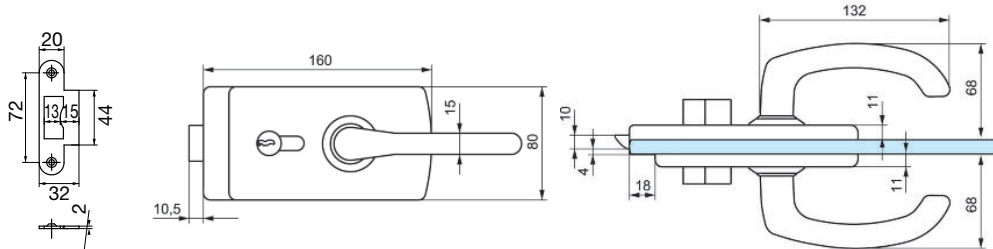

Références / References



Chromé mat
Matt chromium

Serrure de milieu à barillet et béquilles avec déport, condamnation sans avancement de pêne
Lock with euro profile cylinder offset and handles without forward motion of latch bolt

4366.31.0

- Le mécanisme déporté permet un contact de la porte en fond de feuillure, et assure la continuité du joint au niveau de la serrure.
- Offset mechanism to allow compression of rebate strip.



ASSA ABLOY

49

Serrures et paumelles
Locksets and hinges

4380

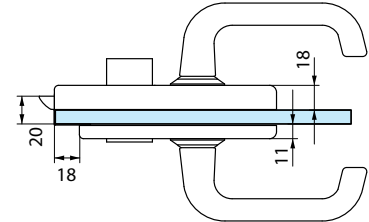
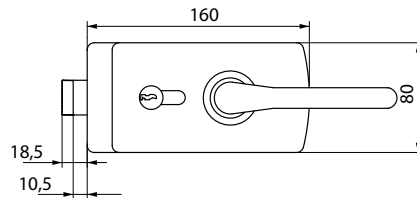
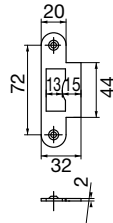
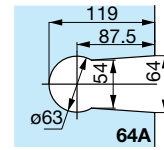

Références / References

Serrure de milieu à cylindre et béquilles avec déport, pêne désaxé, condamnation sans avancement de pêne
Lock set with handles, offset mechanism and spring bolt without forward motion of latch bolt



Chromé brillant
Bright chromium



Chromé mat
Matt chromium



Laqué blanc 9010
Lacquered white RAL 9010



4380.30.0

4380.31.0

4380.51.0



4380.31.4

• Le mécanisme déporté permet un contact de la porte en fond de feuillure, et assure la continuité du joint au niveau de la serrure.

• Offset mechanism to allow compression of rebate strip.

4381

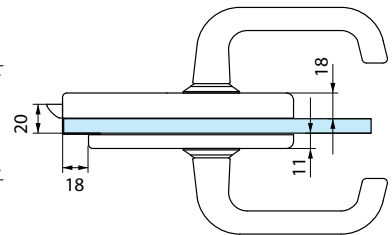
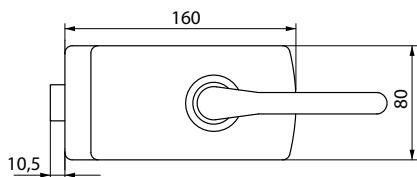
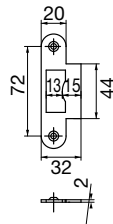
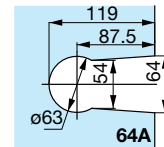

Références / References



Chromé brillant
Bright chromium



Chromé mat
Matt chromium



Laqué blanc 9010
Lacquered white RAL 9010

Serrure de milieu bec de cane et béquilles avec déport, pêne désaxé,
Latch with with handles, offset mechanism and spring bolt,

4381.30.0

4381.31.0

4381.51.0

• Le mécanisme déporté permet un contact de la porte en fond de feuillure, et assure la continuité du joint au niveau de la serrure.

• Offset mechanism to allow compression of rebate strip.

4389

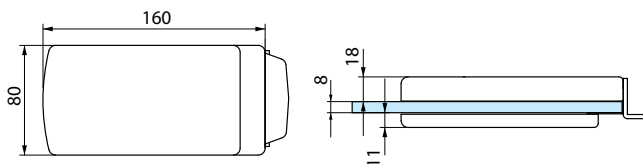
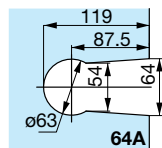

Serrures et
paumelles
Locksets and
hinges

Références / References



Boîtier gâche pour serrures série 4380 - 4381
Matching patch keep for locks series 4380 - 4381



Chromé brillant
Bright chromium



Chromé mat
Matt chromium

4389.30.0

4389.31.0

KITS SERRURE / KIT LOCK



Visuel non contractuel - contenu peut varier
Photo non contractual - contents can differ.

Références / References

Kit complet / Complete Kit



Chromé brillant
Bright chromium



Chromé mat
Matt chromium



Laqué Blanc
Lacquered white



Kit serrure 4300 + 2 paumelles 4200 et 2 fiches 3206
Kit lock 4300 + 2 hinges 4200 and 2 butts 3206

4300.30.0K

4300.31.0K

4300.51.0K



Kit serrure 4301 + 2 paumelles 4200 et 2 fiches 3206
Kit lock 4301 + 2 hinges 4200 and 2 butts 3206

4301.30.0K

4301.31.0K

4301.51.0K



Kit serrure 4360 + 2 paumelles et fiches 4203
Kit lock 4360 + 2 hinges and butts 4203

4360.30.0K

4360.31.0K

4360.51.0K



Kit serrure 4361 + 2 paumelles et fiches 4203
Kit lock 4361 + 2 hinges and butts 4203

4361.30.0K

4361.31.0K

4361.51.0K

Serrures et
paumelles
*Locksets and
hinges*

Bastille



Caractéristiques techniques

- Pour verre trempé de 8 - 10 et 12 mm
- Montage sur encoche 6300EX
- Réversible
- A cylindre européen panneton DIN (norme DIN 18254)
- Avec caches cylindre
- Rappel du pêne à la clé
- Condamnation avec avancement du pêne
- Possibilités de combinaison avec passe général
- Livrée avec gâche plate et 3 clés

Technical features

- For 8 -10 and 12 mm thick toughened glass
- To fit notch 6300EX
- Reversible
- European profile cylinder (DIN standard 18254)
- With cylinder covers
- Return of the latch bolt by key
- Locked with forward motion of latch bolt
- Possibility of combinations with master key
- Supplied with flat keep and 3 keys

LES + PRODUITS

The + product

Design épuré

Certifié TUV

Grande qualité
de finition

Mécanisme
de précision

Réversible

Refined design

TUV certified

High quality finishes

Precision mechanics

Reversible

- Le mécanisme déporté permet un contact de la porte en fond de feuillure, et assure la continuité du joint au niveau de la serrure.

- *Offset mechanism to allow compression of rebate strip.*



4501

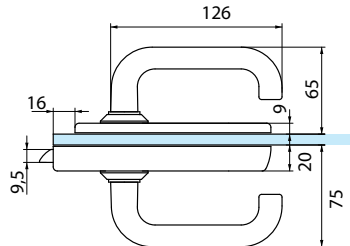
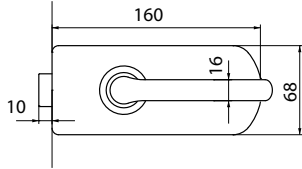
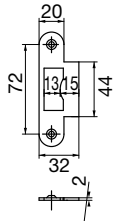
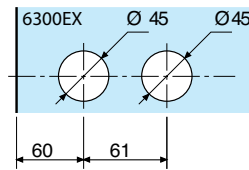

Références / References



Serrure de milieu bec de cane et béquilles
Latch set with pair of handles



Laiton poli PVD
Polished brass PVD

4501.05.0



Chromé brillant
Bright chromium

4501.30.0



Chromé mat
Matt chromium

4501.31.0

4550.**.*

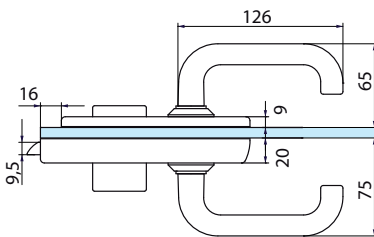
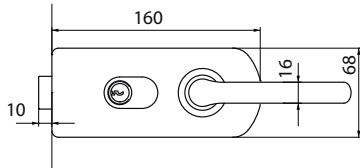
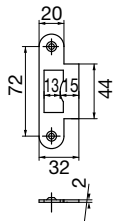
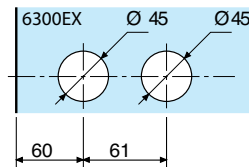

Références / References

Serrure de milieu à cylindre et double béquilles, caches cylindre
Lock with euro profile cylinder, pair of handles and cylinder cover



Laiton poli PVD
Polished brass PVD

4550.05.0



Chromé brillant
Bright chromium

4550.30.0



Chromé mat
Matt chromium

4550.31.0



4550.05.4

4550.30.4

4550.31.4

4550.05.5

4550.30.5

4550.31.5

Serrures et paumelles
Locksets and hinges

4555.**.0

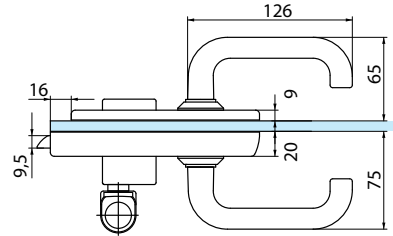
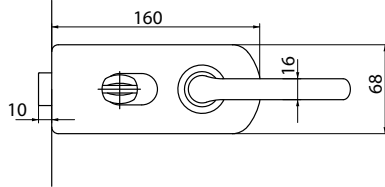
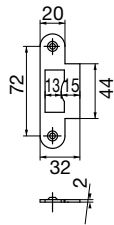
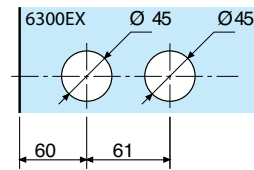

Références / References

Serrure de milieu avec cylindre à bouton et double bécquilles, caches cylindre
Lock with thumb turn cylinder, pair of handles and cylinder cover



Laiton poli PVD
Polished brass PVD



Chromé brillant
Bright chromium



Chromé mat
Matt chromium



4555.05.0

4555.30.0

4555.31.0



4555.05.4

4555.30.4

4555.31.4



4555.05.5

4555.30.5

4555.31.5

4509

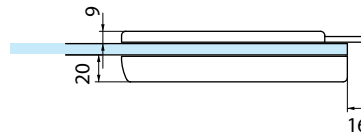
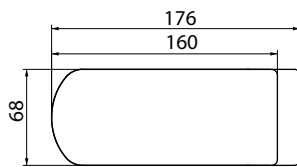
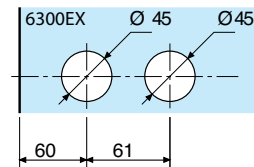

Références / References



Boîtier gâche pour serrures série 4500
Matching patch keep for locks series 4500



Laiton poli PVD
Polished brass PVD



Chromé brillant
Bright chromium



Chromé mat
Matt chromium

4509.05.0

4509.30.0

4509.31.0

Serrures et
paumelles
*Locksets and
hinges*

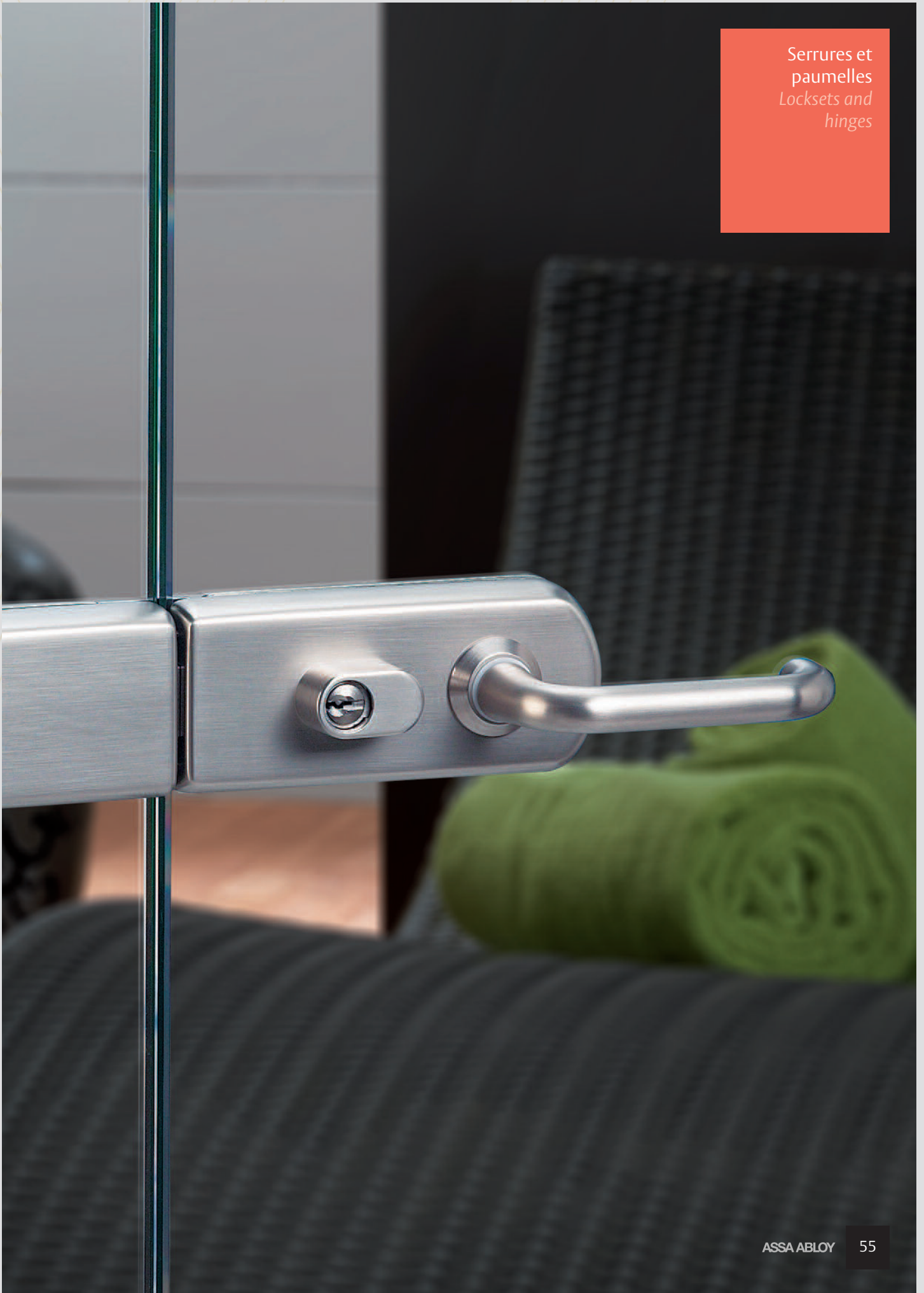

ASSA ABLOY

55

Serrures et
paumelles
Locksets and
hinges

Lumira



Caractéristiques techniques

- Pour verre trempé de 8, 10 et 12 mm
- Montage sur encoche 6300EX
- Réversible
- Condamnation par clé avec avancement du pêne
- Rappel du pêne tour à la clé
- Livré avec gâche plate

Technical features

- For 8- 10 and 12 mm thick toughened glass
- To fit notch 6300EX
- Reversible
- Locked by key with forward motion of latch bolt
- Retractable latch bolt by key
- Supplied with flat keep

LES + PRODUITS

The + product

Mécanisme
déporté

Résistance à l'usage
intensif

Nombreuses
versions

Offset mechanism

Resistance
to heavy use

Large variety
of models

V525

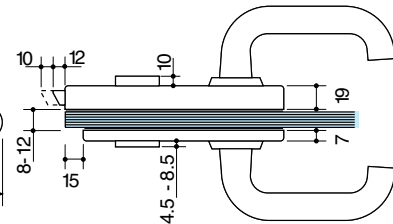
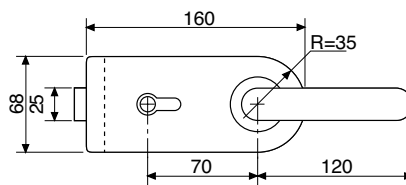
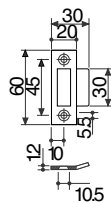
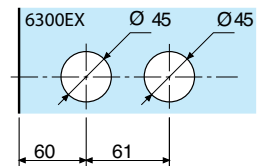

Références / References



Serrure de milieu avec cylindre Européen
avec béquilles
Lock with euro profile cylinder and handles

Aluminium anodisé Argent Brossé
Brushed anodised alu silver

V525.12

- Le mécanisme déporté permet un contact de la porte en fond de feuillure, et assure la continuité du joint au niveau de la serrure.

- Offset mechanism to allow compression of rebate strip.

V526

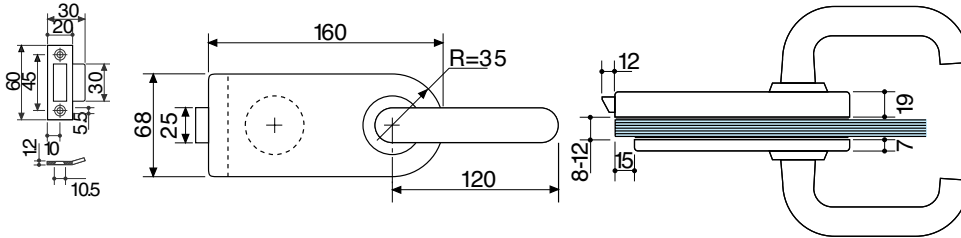
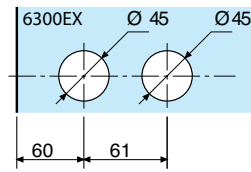

Références / References



Serrure de milieu avec béquille
Latch set with handles



Aluminium anodisé Argent Brossé
Brushed anodised alu silver

V526.12

- Le mécanisme déporté permet un contact de la porte en fond de feuillure, et assure la continuité du joint au niveau de la serrure.

- Offset mechanism to allow compression of rebate strip.

V350

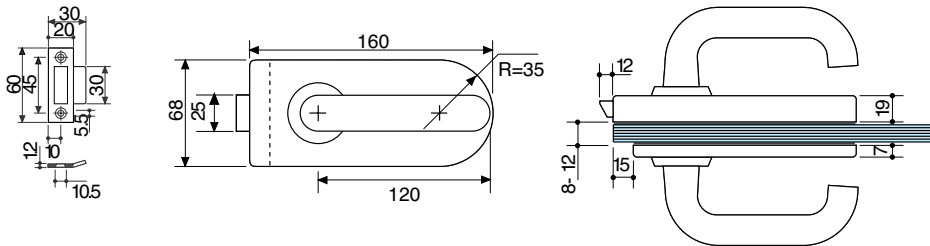
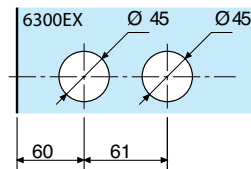

Références / References



Serrure de milieu avec béquilles
Latch set with handles



Aluminium anodisé Argent Brossé
Brushed anodised alu silver

V350.12

- Le mécanisme déporté permet un contact de la porte en fond de feuillure, et assure la continuité du joint au niveau de la serrure.

- Offset mechanism to allow compression of rebate strip.

Serrures et paumelles
Locksets and hinges

Serrures et paumelles
Locksets and hinges

V310

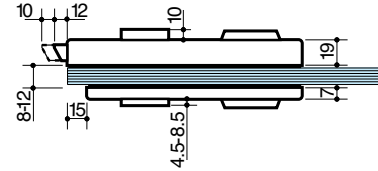
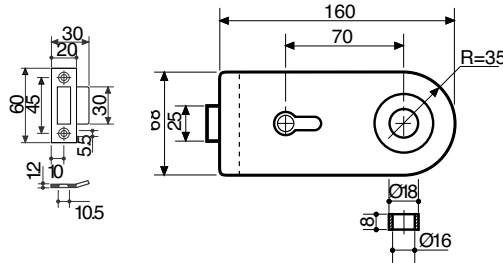
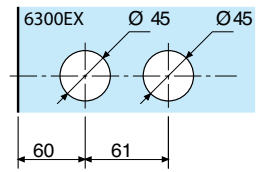

Références | References



Serrure de milieu sans cylindre et pour bouton ou double béquilles
Lock without cylinder and pair of handles or knobs



V310.12

V310.15

V310.36

• Le mécanisme déporté permet un contact de la porte en fond de feuillure, et assure la continuité du joint au niveau de la serrure.

• Offset mechanism to allow compression of rebate strip.

V330

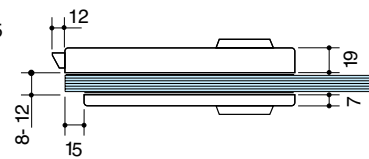
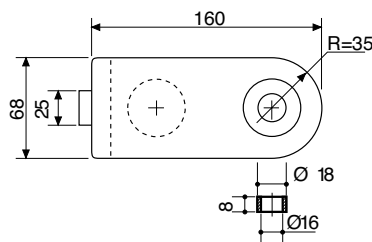
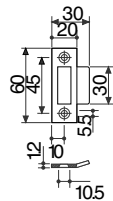
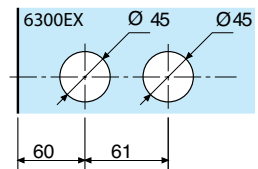

Références | References



Serrure de milieu sans béquille
Latch set without handles



V330.12

V330.15

V330.36

• Le mécanisme déporté permet un contact de la porte en fond de feuillure, et assure la continuité du joint au niveau de la serrure.

• Offset mechanism to allow compression of rebate strip.

V340

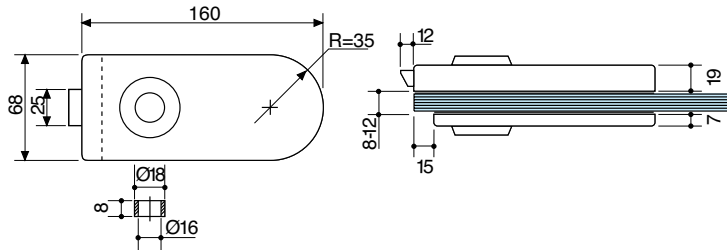
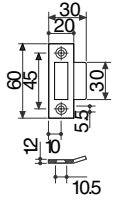
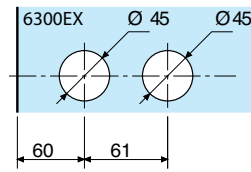

Références / References



Serrure de milieu sans béquille
Latch set without handles



V340.12

V340.15

V340.36

• Le mécanisme déporté permet un contact de la porte en fond de feuillure, et assure la continuité du joint au niveau de la serrure.

• Offset mechanism to allow compression of rebate strip.

V527

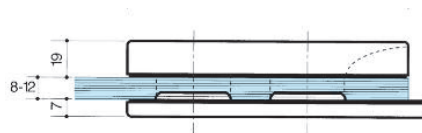
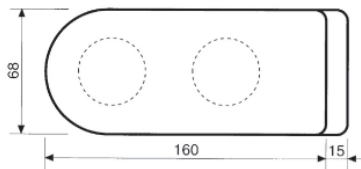
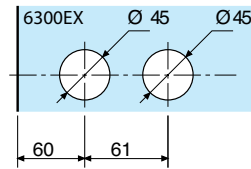

Références / References



Boîtier Gâche pour serrure de milieu série Lumira horizontale.
Matching patch keep for lock series Lumira horizontal



V527.12

V527.15

V527.36

Serrures et paumelles
Locksets and hinges

Serrures et paumelles
Locksets and hinges

V750

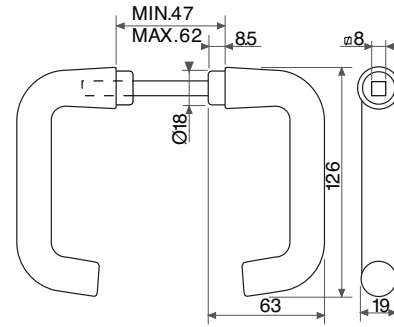

Aluminium anodisé Argent Brossé
Brushed anodised alu silver

Inox Brossé
Brushed stainless steel

V750.12

V750.15

Références / References

Paire de béquilles forme ronde pour V310, V320, V330 et V340
Pair of lever handles rounded design for V310, V320, V330 and V340



V525.5.**

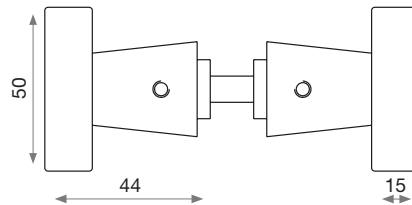

Aluminium anodisé Argent Brossé
Brushed anodised alu silver

Références / References

Paire de boutons pour V310, V320, V330 et V340
Pair of door knobs for V310, V320, V330 and V340

V525.5.12

V554.2

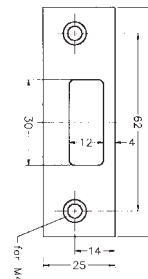

Inox Brossé
Brushed stainless steel

Références / References

Gâche pour V310, V320, V330 et V340 type allemand
Keep plate for V310, V320, V330 and V340 german style

V554.2.15

4391.00.0

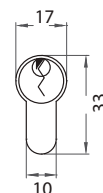
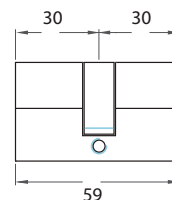
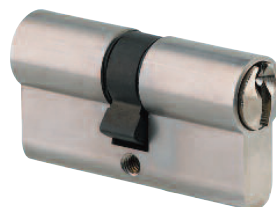

Références / References



Cylindre Européen 30/30 mm
Europrofile cylinder 30/30 mm

4391.00.0

V533.1

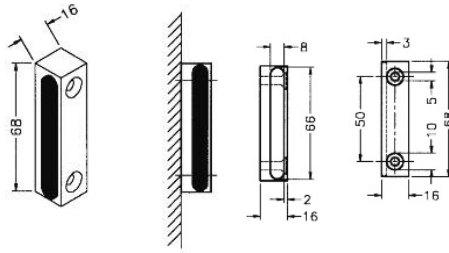

Laiton poli verni
Polished varnished brass



Aluminium anodisé Argent Brossé
Brushed anodised alu silver



Chromé brillant
Bright chromium



Chromé mat brossé
Brushed matt chromium



Aluminium anodisé Aninox
Brushed anodised alu.

Références / References

Butée pour serrure de milieu
Wall stop for locks

V533.1.01

V533.1.12

V533.1.30

V533.1.33

V533.1.36

Serrures et
paumelles
Locksets and
hinges

KITS SERRURE / KIT LOCK



Visuel non contractuel - contenu peut varier
Photo non contractuel - contents can differ.



Références / References

Kit complet / Complete Kit



Aluminium anodisé Argent Brossé
Brushed anodised alu silver



Aluminium anodisé Aninox
Brushed anodised alu.



Kit serrure V525 + 2 paumelles V505.2 et 2 caches fiches 4205
Kit lock V525 + 2 hinges V505.2 and 2 covers for butt 4205

V310.12K

V320.36K



Kit serrure V526 + 2 paumelles V505.2 et 2 caches fiches 4205
Kit lock V526 + 2 hinges V505.2 and 2 covers for butt 4205

V330.12K

V330.36K



Kit serrure V350 + 2 paumelles V505.2 et 2 caches fiches 4205
Kit lock V350 + 2 hinges V505.2 and 2 covers for butt 4205

V340.12K

V340.36K



Kit contre boîtier V527 + 2 paumelles V505.2 et 2 caches fiches 4205
Kit matching patch keep V527 + 2 hinges V505.2 and 2 covers for bu tt 4205

V527.12K



Kit serrure V525 + 2 paumelles V505
Kit lock V525 + 2 hinges V505

V310.12KB

V310.36KB



Kit serrure V526 + 2 paumelles V505
Kit lock V526 + 2 hinges V505

V330.12KB



Kit serrure V350 + 2 paumelles V505
Kit lock V350 + 2 hinges V505

V340.12KB

V340.36KB



Kit contre boîtier V527 + 2 paumelles V505
Kit matching patch keep V527 + 2 hinges V505

V527.12KB

Serrures et paumelles
Locksets and hinges

Vertis

Caractéristiques techniques

- Pour verre trempé de 8, 10 et 12 mm
- Montage sur encoche V370E
- Avec pêne demi tour et pêne dormant

Technical features

- For 8-10 and 12 mm thick toughened glass
- To fit notch V370E
- With spring and dead bolt



LES + PRODUITS

The + product

Grande qualité de finition

Résistance à l'usage intensif

Sécurité accrue

High quality finishes

Resistance to heavy use

Increased security



V360

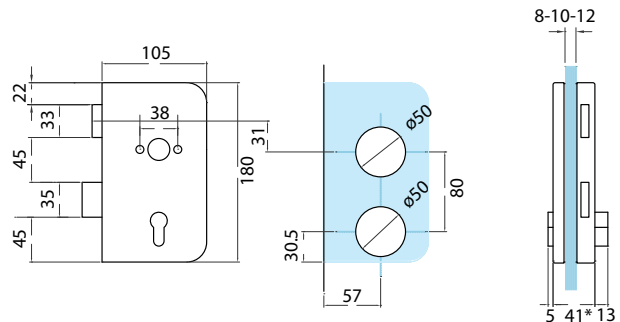
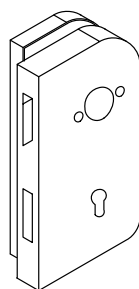

Références / References



Serrure de milieu pour cylindre Européen sans béquille, DIN droite
Lock for Euro profile cylinder without handles DIN right

Aluminium anodisé Argent Brossé
Brushed anodised alu silver

Inox Brossé
Brushed stainless steel

V360.12

V360.15

V370

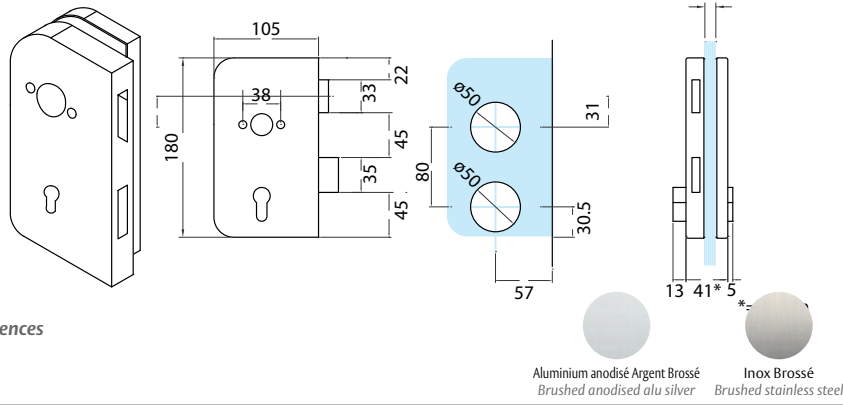

Références / References



Serrure de milieu pour cylindre Européen sans béquille, DIN gauche
Lock for Euro profile cylinder without handles DIN left

V370.12

V370.15

Serrures et
paumelles
Locksets and
hinges

V367

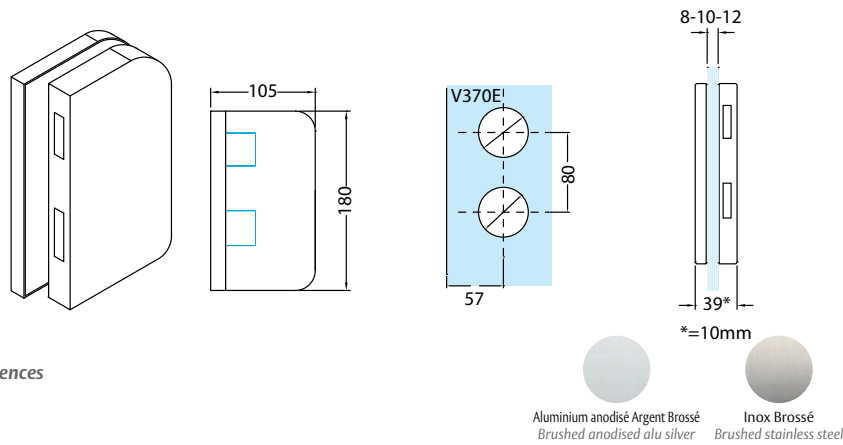

Références / References



Boîtier gâche pour serrure de milieu pour V370 / DIN droite
Matching patch keep for lock V370 / DIN right

V367.12

V367.15

V377

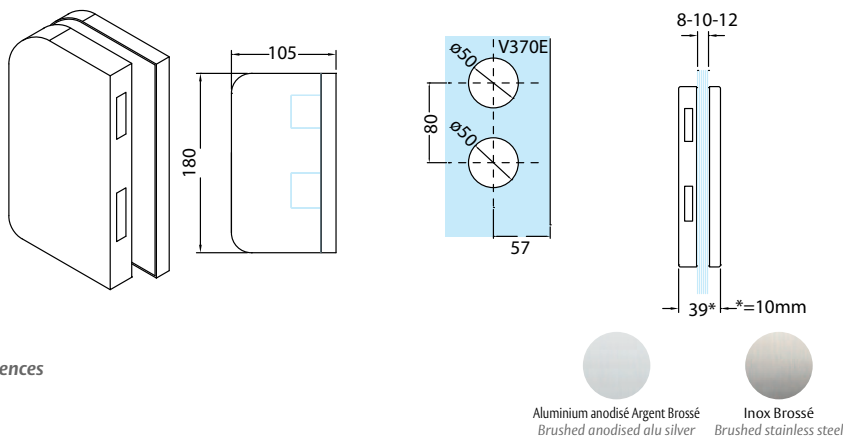

Références / References



Boîtier gâche pour serrure de milieu pour V360 / DIN gauche
Matching patch keep for centre lock V360 / DIN left

V377.12

V377.15

Serrures et
paumelles
*Locksets and
hinges*

Vertis SQ

Caractéristiques techniques

- Pour verre trempé de 8, 10 et 12 mm
- Montage sur encoche V370E
- Avec pêne demi tour et pêne dormant

Technical features

- For 8-10 and 12 mm thick toughened glass
- To fit notch V370E
- With spring and dead bolt



LES + PRODUITS

The + product

Grande qualité
de finition

Résistance à l'usage
intensif

Sécurité accrue

High quality finishes

*Resistance
to heavy use*

Increased security



V360SQ

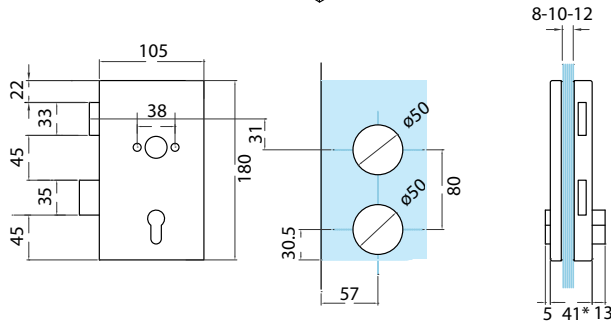
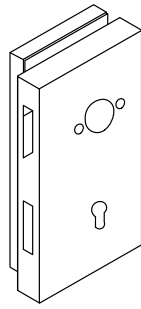

Références / References



*=10mm



Inox Brossé
Brushed stainless steel

Serrure de milieu pour cylindre Européen sans béquille, DIN droite
Lock for Euro profile cylinder without handles DIN right

V360SQ.15

V370SQ

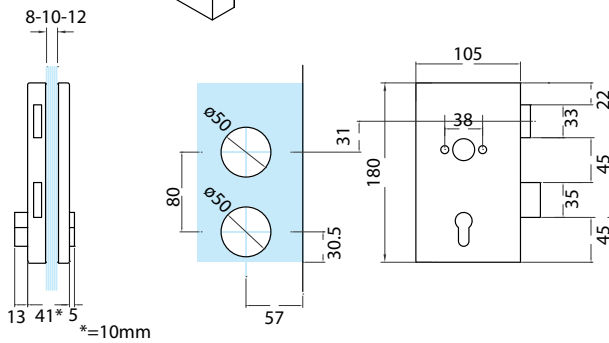
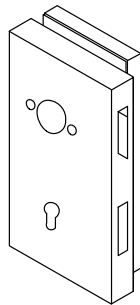

Références / References



*=10mm



Inox Brossé
Brushed stainless steel

Serrure de milieu pour cylindre Européen sans béquille, DIN gauche
Lock for Euro profile cylinder without handles DIN left

V370SQ.15

Serrures et
paumelles
Locksets and
hinges

Serrures et
paumelles
Locksets and
hinges

V770

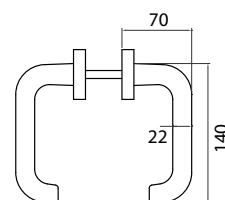

Références / References

Paire de béquilles avec rosace pour V360, V370, V360SQ et V370SQ
Pair of lever handles with rosettes for V360, V370, V360SQ et V370SQ

V770.12

V770.15



V780

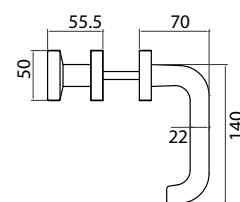

Références / References

Bouton fixe / béquille pour V360, V370, V360SQ et V370SQ
Combination fixed knob / lever handle for V360, V370, V360SQ et V370SQ

V780.12

V780.15

V2140

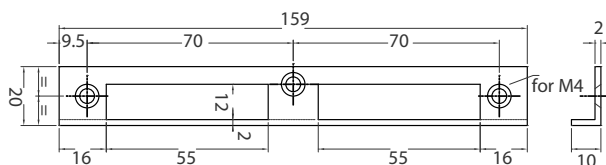

Références / References

Gâche forme L pour V360, V370
Keep plate L shape for V360, V370

V2140.15

V2140.2

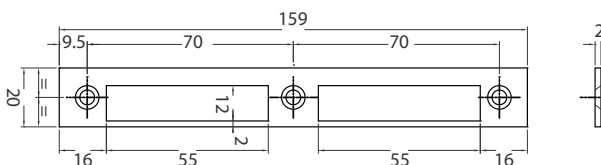

Références / References

Gâche pour V360, V370
Keep plate for V360, V370

V2140.2.15

4391.00.0

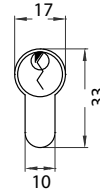
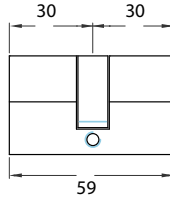

Serrures et
paumelles
Locksets and
hinges

Références / References

Cylindre Européen 30/30 mm
Europrofile cylinder 30/30 mm

4391.00.0

V533.1

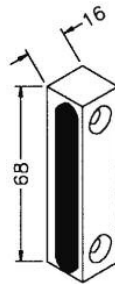

Laiton poli verni
Polished varnished brass



Aluminium anodisé Argent Brossé
Brushed anodised alu silver



Chromé brillant
Bright chromium



Chromé mat brossé
Brushed matt chromium



Aluminium anodisé Aninox
Brushed anodised alu.

Références / References

Butée pour serrure de milieu
Wall stop for lock

V533.1.01

V533.1.12

V533.1.30

V533.1.33

V533.1.36

2881.15.0



Inox Brossé
Brushed stainless steel

Références / References

Butée de porte Ø 35 mm hauteur 40 mm
Door stop 35 Ø X 40 mm height

2881.15.0

Serrures et
paumelles
*Locksets and
hinges*

Classic



Caractéristiques techniques

- Pour verre trempé de 8, 10 mm
- Montage sur encoche 64A avec cale d'encoche et sur les anciennes encoches 60A, 60B, 64
- Réversible par retournement du pêne demi-tour pour adaptation selon sens d'ouverture de la porte
- Pêne demi tour et pêne dormant indépendants
- A cylindres avec protection par bagues tournantes
- Rappel du demi-tour à la clé
- Livré avec gâche plate, 3 clés et cale d'encoche

Technical features

- For 8 and 10 mm thick toughened glass
- To fit notch 64A with notch wedge supplied and on notches 60A, 60B and 64
- Reversible by altering latch bolt to adapt to the opening direction of the door
- Individual latch and dead bolt
- Protected cylinder
- Return of latch bolt with moring collar
- Supplied with flat keep, 3 keys and notch wedge

LES + PRODUITS

The + product

Grande qualité
de finition

Compatible
anciennes encoches

Sécurité :
pêne dormant
indépendant

High quality finishes

*Compatible with long
standing notches*

*Security :
independant bolt*



1300

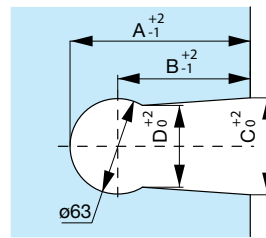
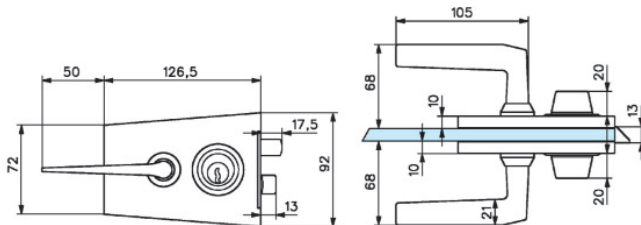

Encoche	A	B	C	D
60A	94,5	62	62	51
60B	94,5	63	65	57
64	110	78,5	65	54
64A	119	87,5	64	54

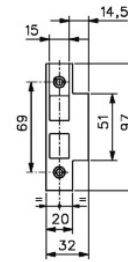

Références / References



Serrure de milieu à cylindre et double béquilles
Lock with cylinder and double handles



Chromé brillant
Bright chromium



Chromé mat
Matt chromium

1300.30.0

1300.31.0

1309

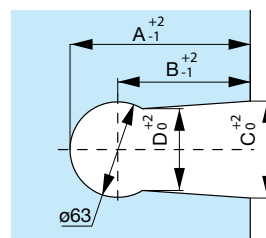
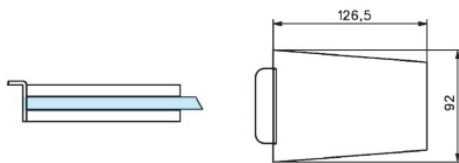

Encoche	A	B	C	D
60A	94,5	62	62	51
60B	94,5	63	65	57
64	110	78,5	65	54
64A	119	87,5	64	54

Références / References



Boîtier gâche pour serrures série 1300
Matching patch keep for locks series 1300



Chromé brillant
Bright chromium



Chromé mat
Matt chromium

1309.30.0

1309.31.0

Serrures et paumelles
Locksets and hinges

Open Glass



Caractéristiques techniques

- Kit de transformation d'une porte en bois par une porte en verre.
- Pour verre trempé de 8 mm
- Hauteur maxi dans la feuillure 2200 mm
- Largeur maxi dans la feuillure 1000 mm
- Pour des feuillures de 35 à 48 mm de profondeur

Technical features

- Kit for transformation of wooden door to glass door
- Pour verre trempé de 8 mm
- Maximum height in the frame 2200 mm
- Maximum width in the frame 1000 mm
- For frames of 35 to 48 mm in depth

LES + PRODUITS

Design
Confort
Simplicité
et rapidité de pose

Design
User comfort
Quick and easy
assembling

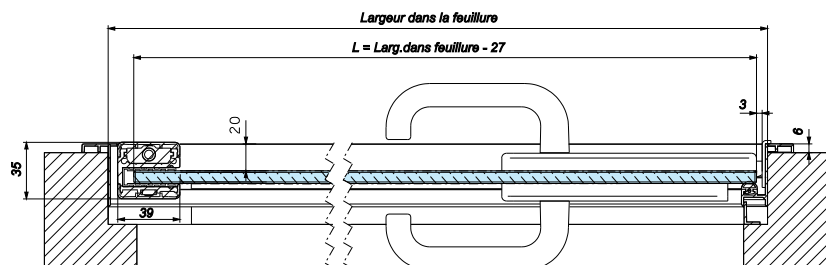
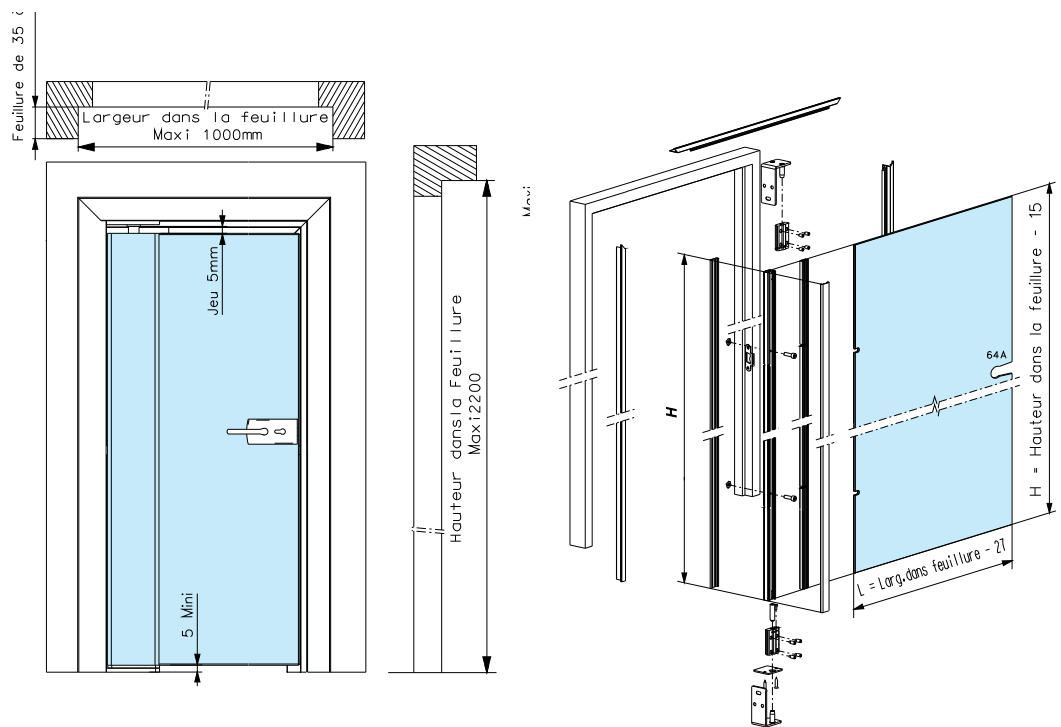

Références | References



Aluminium anodisé Argent Brossé
Brushed anodised alu silver

Laqué blanc 9010
Lacquered white RAL 9010

Kit rénovation pour porte intérieure
Renovation kit for interior door

KPR01/08.12

KPR01/08.51

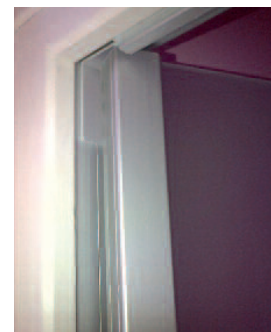

Ce kit comprend

- 2 Profils verticaux lg 2200 mm et 1 profil horizontal lg 1000 mm pour l'habillage du bât.
- 5 mètres de joint périphérique
- 1 Profil articulé avec capots et pivots Haut et Bas intégrés
- Livré avec vis de fixation et gâche plate spécifique pour serrure réf : 4360.**0 et 4361.**0

This kit includes

- 2 vertical profiles 2200 mm in length and 1 horizontal profile 1000 mm in length for the casing
- 5 metres of seal for frame
- 1 hinged profile with top and bottom integrated pivots and cover
- Delivered with fixing screws and flat strike plate compatible with the lock ref 4360.**0 and 4361.**0

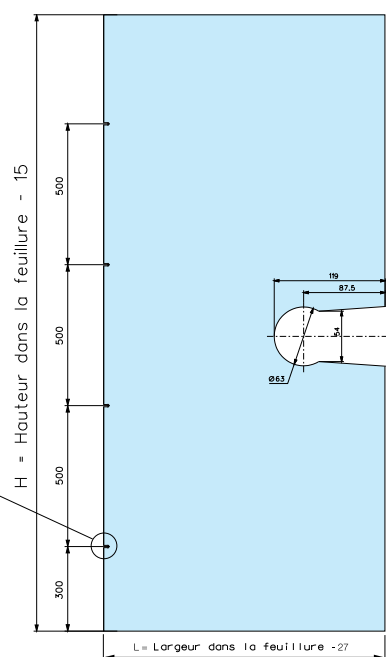
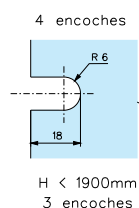

Serrures et paumelles
Locksets and hinges

Doorframe



LES + PRODUITS
The + product

Esthétique
Etanchéité acoustique
Installation facile

Elegant design
Sound proofed
Easy installation

Caractéristiques techniques

- Pour porte en verre trempé de 8, 10 et 12 mm
- Pour panneaux fixe de 8, 10, 12 et 15 mm
- Profil permettant d'appliquer différentes charnières
- Compatible avec les serrures séries LUMIRA, LUMIRA vertical, BASTILLE, LAGUNE
- Le galet de blocage RS02 peut être installé avec une paire de poignées ou une paire de boutons
- Possibilité d'intégration d'une gâche électrique (voir chapitre contrôle d'accès)
- Permet l'intégration facile d'une porte en verre dans un ensemble Sécurité
- Utilisation des profils KL001 et KL002 recommandé pour fixation de l'ensemble

Technical features

- For doors of 8, 10 and 12 mm thick toughened glass
- For fixed panels of 8, 10, 12 and 15 mm
- Profile allowing several different hinges
- Compatible with lock series LUMIRA, LUMIRA vertical, BASTILLE, LAGUNE
- A blocking roller keep can be installed so handles or door knobs can be used
- Possible installation of an electric release keep (see chapter access control)
- Allows an easy integration of a glass door in a Securit set
- Use KL001 and KL002 profiles recommended to fix the frames

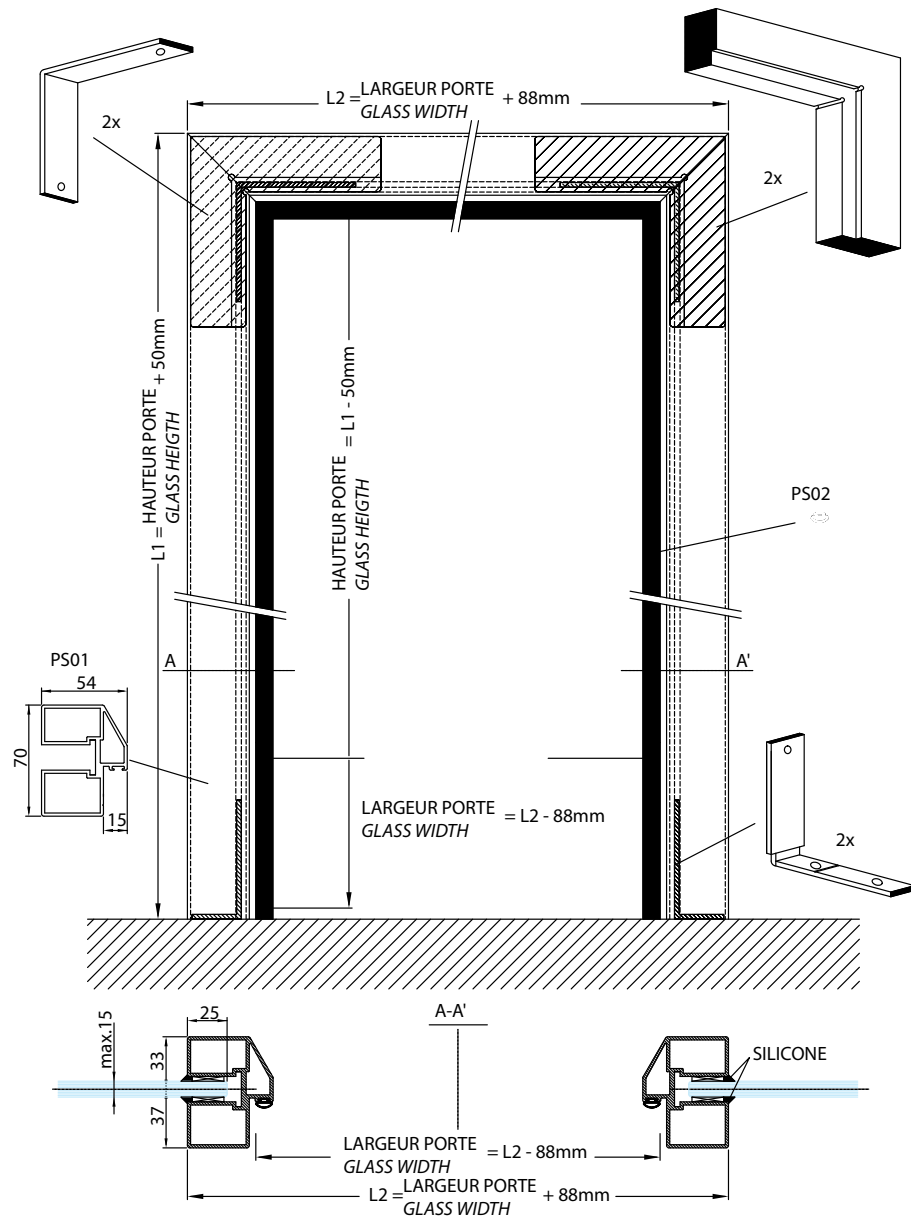



Serrures et paumelles
Locksets and hinges



PS01MST



DIN GAUCHE / DIN LEFT

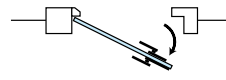

PS01MST/08L.XX

DIN DROITE / DIN RIGHT

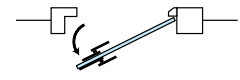

PS01MST/08R.XX

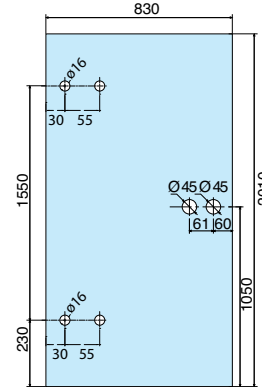

Références / References



Kit complet profil d'encadrement porte en verre de 830 x 2010 mm avec serrure V310 + V750 et paumelles V504
Complete Kit door frame profile for 830 x 2010 mm glass doors with lock V310 + V750 and hinges V504



Aluminium anodisé Argent Brossé
Brushed anodised alu silver



Aluminium anodisé Aninox
Brushed anodised alu.

DIN gauche DIN left

PS01MST/08L.12

PS01MST/08L.36

DIN droite DIN right

PS01MST/08R.12

PS01MST/08R.36

PS

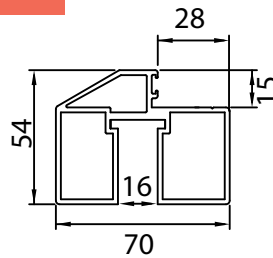

Références / References



Profil d'encadrement vertical longueur 2500 mm
2500 mm length profile for vertical door frame



Aluminium anodisé Argent Brossé
Brushed anodised alu silver



Aluminium anodisé Aninox
Brushed anodised alu.

PS2500.12

PS2500.36

Profil d'encadrement horizontal longueur 1500 mm
1500 mm length profile for horizontal door frame

PS1500.12

PS1500.36

PS02.99



Références / References

Joint pour encadrement porte en verre - le mètre
Rubber strip for door frame - per meter

PS09.99

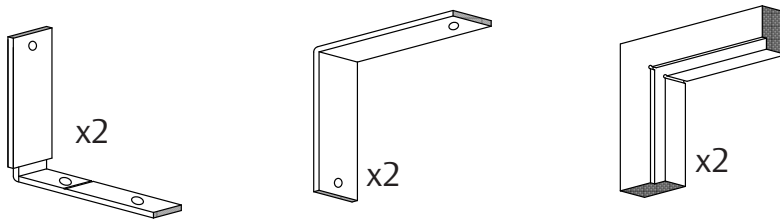

Kit de fixation d'angle pour profil encadrement PS01, vis de fixation inclus
 Corner mounting kit for doorframe profil PS01, including fixing screws

Serrures et
 paumelles
 Locksets and
 hinges

V504

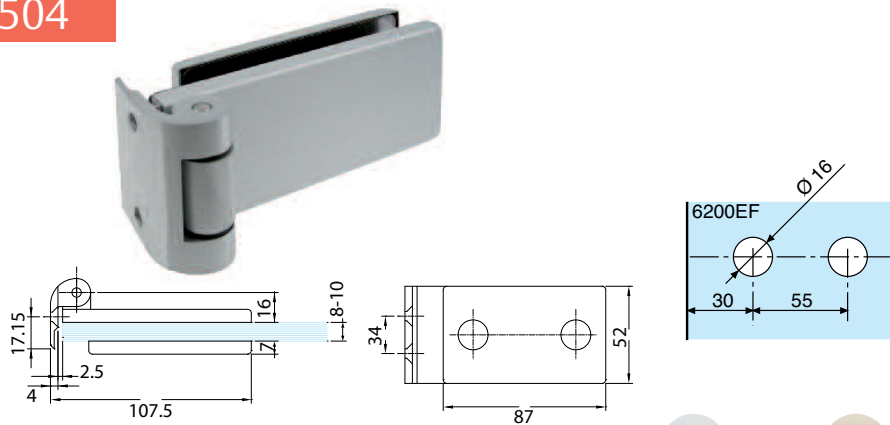

Références / References

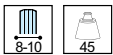

Aluminium anodisé Argent Brossé / Brushed anodised alu silver
 Aluminium anodisé Aninox / Brushed anodised alu.

V504.12

V504.36

Paumelle et fiche pour profil alu encadrement porte en verre PS01
 Hinge and multi rebate butt for door frame aluminium profile for glass door PS01

RS02.99

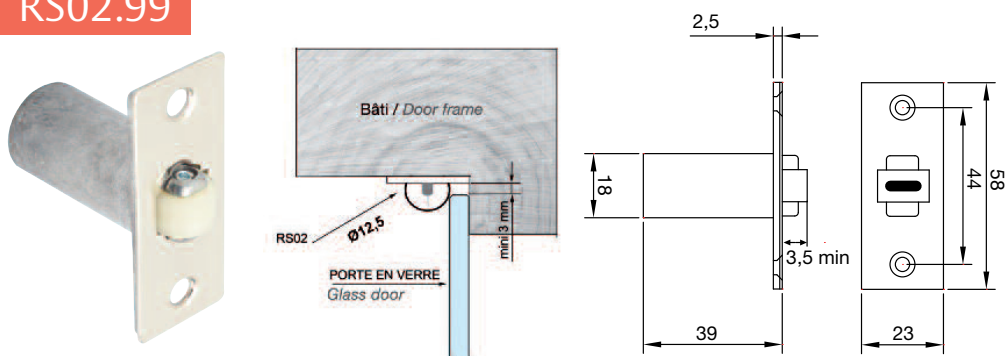

Galet avec rouleau nylon, réglable (3 à 10 mm)
 Blocking roller keep, adjustable (3 to 10 mm)

Serrures et
paumelles
Locksets and
hinges

2800.66.4

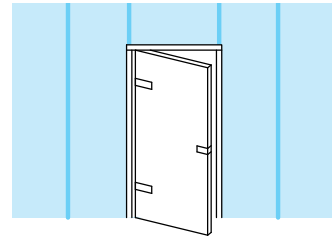
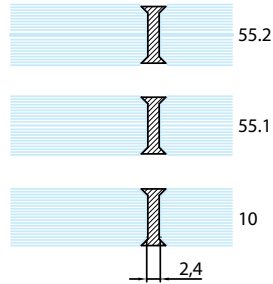
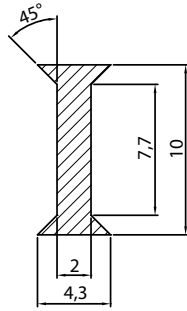

LES + PRODUITS

Esthétique
Installation

Attractive design
Easy installation

Références / References

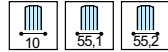

Joint PVC pour verre 10 mm - 55,1 - 55,2 adhésif inclus pour joindre 2 panneaux fixes
Dry glazing profile for glass 10 mm - 55,1 - 55,2 including tape for jointing 2 fixed panels

2800.66.4

- Unité de vente : 1 joint conditionné par 10
- Sold in units : packed by 10

2800.66.5

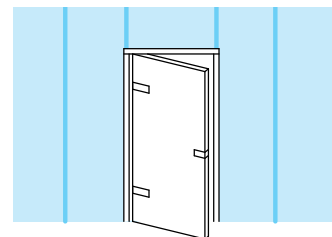
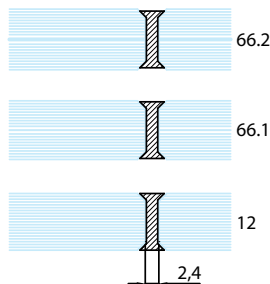
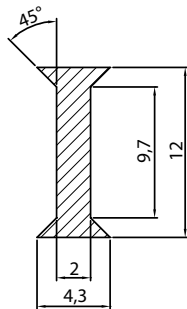

Références / References

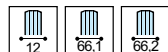

Joint PVC pour verre 12 mm - 66,1 - 66,2 adhésif inclus pour joindre 2 panneaux fixes
Dry glazing profile for glass 12 mm - 66,1 - 66,2 including tape for jointing 2 fixed panels

2800.66.5

- Unité de vente : 1 joint conditionné par 10
- Sold in units : packed by 10

Serrures et
paumelles
*Locksets and
hinges*



ASSA ABLOY

77

Serrures et
paumelles
*Locksets and
hinges*

Paumelles *Hinges*

Lagune & Lumira



Caractéristiques techniques

- Pour verre trempé de 8 à 10 mm
- Montage sur encoche 6200EF
- Dimension maximum des portes 827 mm x 2034 mm
- Poids maximum admissible 45 kg pour 2 paumelles, pour un poids supérieur pose obligatoire d'une 3ème paumelle

Technical features

- For 8 to 10 mm thick toughened glass
- To fit notch 6200EF
- Dimensions size of doors 827 mm x 2034 mm
- Max load 45 kg for 2 hinges, for load exceeding a third hinge must be fitted

LES + PRODUITS

Design des serrures
Lagune et Lumira

*Lagune and Lumira
lock design*



4200

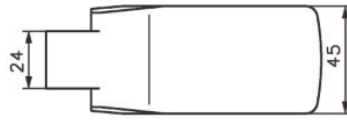
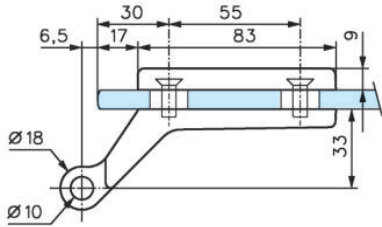
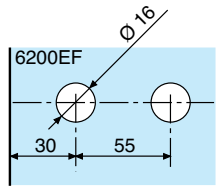

Serrures et
paumelles
Locksets and
hinges

Références / References



Chromé brillant
Bright chromium



Chromé mat
Matt chromium



Effet inox
Stainless steel effect



Doré
Gold plated



Laqué blanc 9010
Lacquered white RAL 9010

Paumelle pour feuillures de 35 à 40 mm,
s'utilise avec les fiches 3204 - 3205 - 3206
Hinge for rebate of 35 to 40 mm, to fit
butts 3204 - 3205 - 3206

4200.30.0

4200.31.0

4200.35.0

4200.40.0

4200.51.0

4201

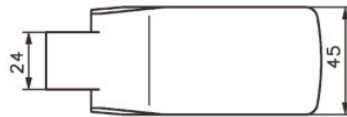
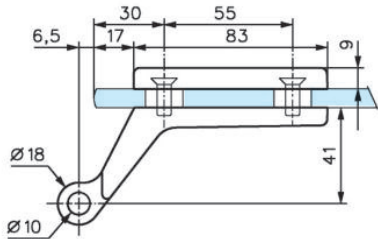
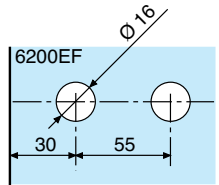

Paumelle pour feuillures supérieures
à 40 mm, s'utilise avec les fiches
3204 - 3205 - 3206
Hinge for rebate larger than 40 mm,
to fit butts 3204 - 3205 - 3206

Références / References



Chromé brillant
Bright chromium



Chromé mat
Matt chromium



Effet inox
Brushed stainless steel



Doré
Gold plated



Laqué blanc 9010
Lacquered white RAL 9010

4201.30.0

4201.31.0

4201.35.0

4201.40.0

4201.51.0



4201.31.5

Serrures et paumelles
Locksets and hinges

4203

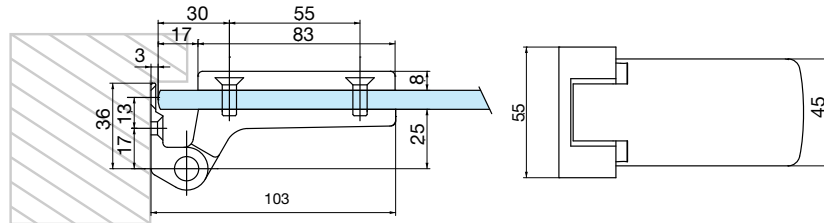
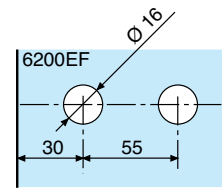

LES + PRODUITS

Montage facile
Tout support

Easy installation
Fits to all kinds of frame

Références / References



Chromé brillant
Bright chromium



Chromé mat
Matt chromium



Effet inox
Stainless steel effect



Doré
Gold plated



Laqué blanc 9010
Lacquered white RAL 9010

Paumelle et fiche multi feuillure pour tous types d'huisseries
Hinge and multi rebate butt for all types of frame

4203.30.0

4203.31.0

4203.35.0

4203.40.0

4203.51.0

V504

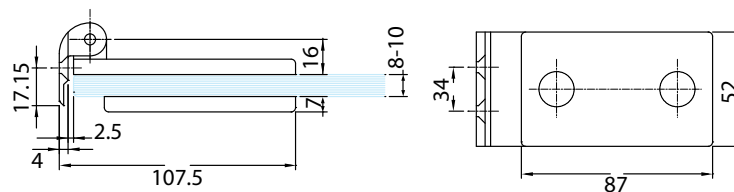
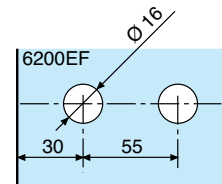

Références / References



Aluminium anodisé Argent Brossé
Brushed anodised alu silver



Aluminium anodisé Aninox
Brushed anodised alu.

Paumelle et fiche pour profil alu encadrement porte en verre PS01
Hinge and multi rebate butt for door frame profile for glass door PS01

V504.12

V504.36

V505

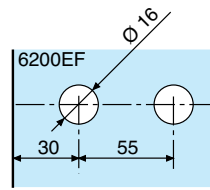

Serrures et
paumelles
Locksets and
hinges

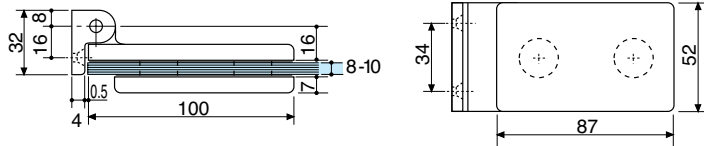

Références / References



- 
Laiton poli verni
Polished varnished brass
- 
Aluminium anodisé Argent Brossé
Brushed anodised alu silver
- 
Chromé brillant
Bright chromium
- 
Chromé mat brossé
Brushed matt chromium
- 
Aluminium anodisé Aninox
Brushed anodised alu.

Paumelle et fiche multi feuillure
pour tous types d'huisseries
*Hinge and multi rebate butt for all
types of frame*

V505.01

V505.12

V505.30.0

V505.33

V505.36

V507

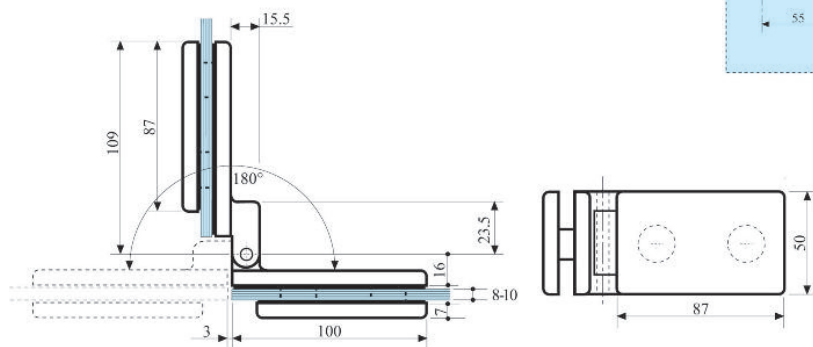
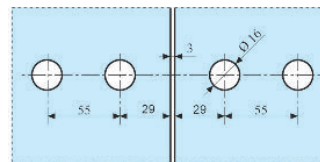

Références / References



- 
Laiton poli verni
Polished varnished brass
- 
Aluminium anodisé Argent Brossé
Brushed anodised alu silver
- 
Chromé brillant
Bright chromium
- 
Chromé mat brossé
Brushed matt chromium
- 
Aluminium anodisé Aninox
Brushed anodised alu.

Paumelle double verre/verre pour portes simple action
Glass to glass hinge for single action doors

V507.01

V507.12

V507.30.0

V507.33

V507.36

Serrures et paumelles
Locksets and hinges

3204

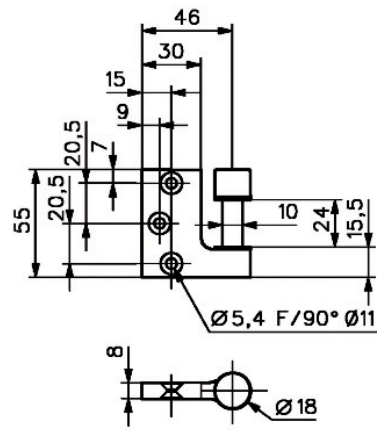

Chromé brillant
Bright chromium



Chromé mat
Matt chromium



Doré
Gold plated



Laqué blanc 9010
Lacquered white RAL 9010

Références / References

Fiche à entailler réversible pour huisseries bois, s'utilise avec les paumelles 4200 et 4201
Reversible flush fixed butt for wooden door frame, to fit to hinges 4200 and 4201

3204.30.0

3204.31.0

3204.40.0

3204.51.0

3206.**.0

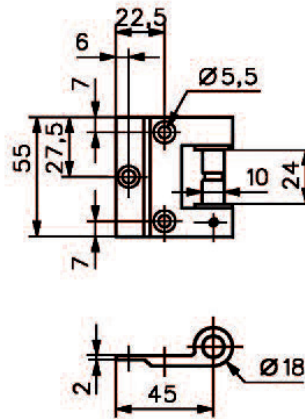

Références / References

Fiche en applique réversible pour toutes huisseries bois, métalliques et aluminium, s'utilise avec les paumelles 4200 et 4201
Reversible surface fixed butt for all types of wooden, metal and aluminium frame, to fit to hinges 4200 and 4201



Laiton poli
Polished brass



Chromé brillant
Bright chromium



Chromé mat
Matt chromium



Effet inox
Stainless steel effect



Doré
Gold plated



Laqué blanc 9010
Lacquered white RAL 9010

3206.00.0

3206.30.0

3206.31.0

3206.35.0

3206.40.0

3206.51.0

3205.**.1

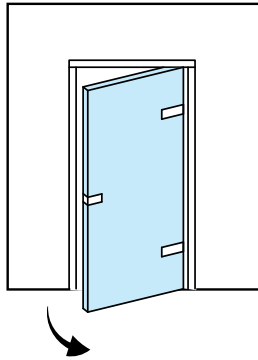
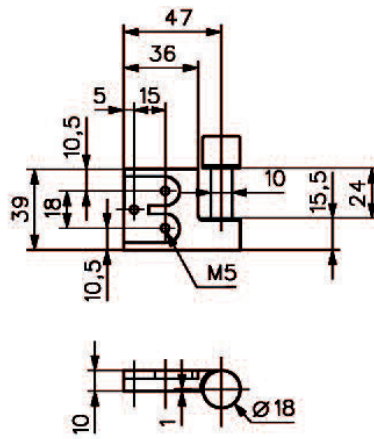

Références / References

Fiche à entailler (main droite) non réversible pour huisseries métalliques, s'utilise avec les paumelles 4200 et 4201

Non reversible mortised butt (right hand) for metal frame, to fit hinges 4200 and 4201



Chromé mat
Matt chromium

3205.31.1

3205.**.2

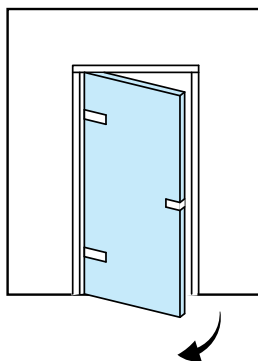
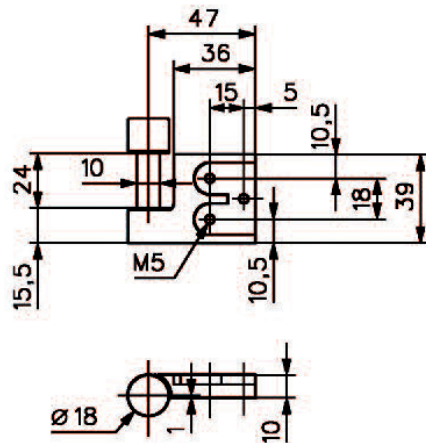

Références / References

Fiche à entailler (main gauche) non réversible pour huisseries métalliques, s'utilise avec les paumelles 4200 et 4201

Non reversible mortised butt (left hand) for metal frame, to fit hinges 4200 and 4201



Chromé mat
Matt chromium

3205.31.2

Serrures et
paumelles
Locksets and
hinges

Paumelles *Hinges*

Bastille



Caractéristiques techniques

- Pour verre trempé de 8, 10 et 12 mm
- Montage sur encoche 6202EX
- Poids maximum admissible 45 kg pour 2 paumelles, largeur maximum 1000 mm, pour un poids supérieur nous consulter

Technical features

- For 8, 10 and 12 mm thick toughened glass
- To fit notch 6202EX
- Max load 45 kg, maximum width 1000 mm, for 2 hinges please consult us for glass weighting more than 45 kg

LES + PRODUITS

Montage facile
Tout support

Easy installation
Fit to all kind of frame

4202

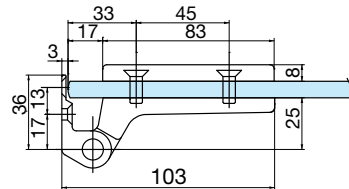
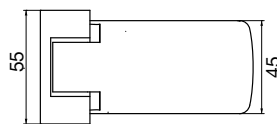
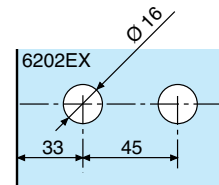

Références / References

Paumelle et fiche multi feuillure
pour tous types d'huissieries
Hinge and multi rebate butt for all
types of frame



4202.05.0

4202.30.0

4202.31.0

4202.35.0

4202.31.5

4202.35.5

4206

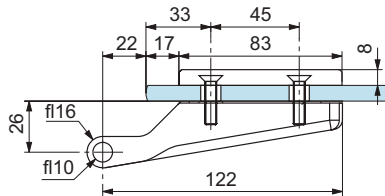
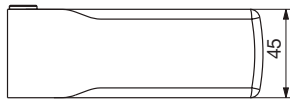
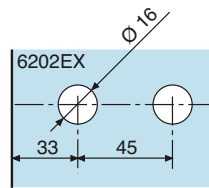

Serrures et
paumelles
Locksets and
hinges

Références / References

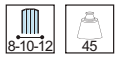

Chromé brillant
Bright chromium



Chromé mat
Matt chromium



Effet inox
Stainless steel effect

Paumelle pour feuillure de 24 mm,
s'utilise avec les fiches 4207 - 4208 - 4209
Hinge for rebate of 24 mm, to fit butts
4207 - 4208 - 4209

4206.30.0

4206.31.0

4206.35.0

V505.2

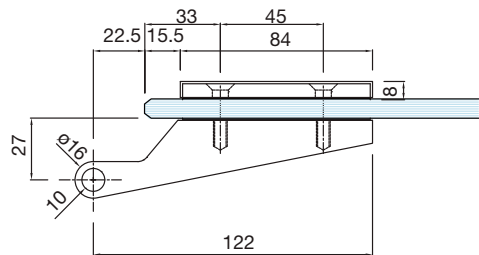
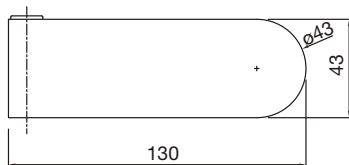
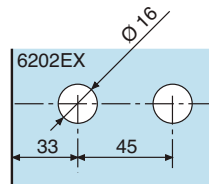

Références / References

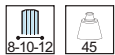

Aluminium anodisé Argent Brossé
Brushed anodised alu silver



Aluminium anodisé Aninox
Brushed anodised alu.

Paumelle pour feuillure de 24 mm, s'utilise
avec les fiches 4207 - 4208 - 4209
Hinge for rebate of 24 mm, to fit butts
4207 - 4208 - 4209

V505.2.12

V505.2.36

Serrures et
paumelles
Locksets and
hinges

4208.99.0

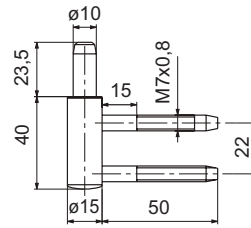
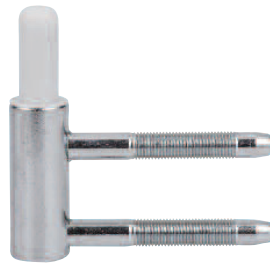

Fiche pour huisseries bois, s'utilise avec la paumelle 4206 et caches fiches 4205
Butt for wooden door frame, to fit hinge 4206 and butt covers 4205

K3172.99

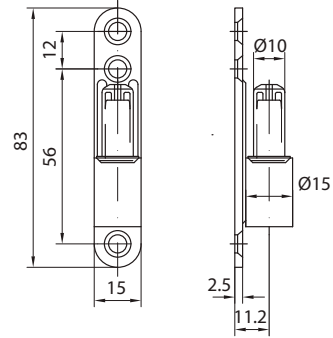

Fiche en applique réversible pour toutes huisseries bois, métalliques et aluminium, s'utilise avec les paumelles 4206 - V505.2 et caches fiches 4205 - V207
Reversible surface fixed butt for all types of wooden, metal and aluminium frame, to fit hinges 4206 - V505.2 and butt covers 4205 - V207

4205

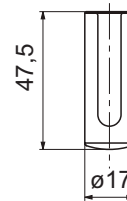

Références / References

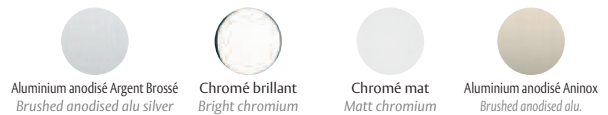

Caches pour fiches 4207 - 4208 - 4209
Covers for butt 4207 - 4208 - 4209

4205.12.0

4205.30.0

4205.31.0

4205.36.0

Paumelles *Hinges*

Serrures et
paumelles
Locksets and
hinges

Vertis

Caractéristiques techniques

- Pour verre trempé de 8 et 10 mm
- Montage sur encoche V380E
- Poids maximum admissible 45 kg pour 2 paumelles, largeur maximum 1000 mm, pour un poids supérieur nous consulter

Technical features

- For 8 and 10 mm thick toughened glass
- To fit notch V380E
- Max load 45 kg, maximum width 1000 mm, for 2 hinges please contact us for glass weighing more than 45 kg

V381

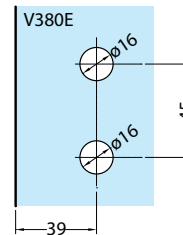
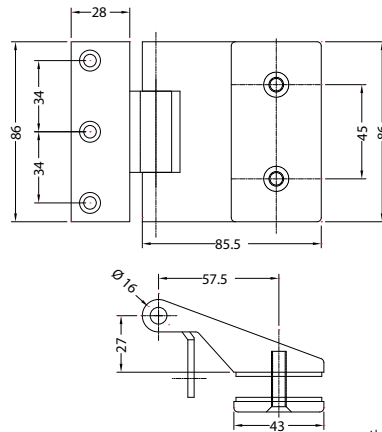

Références / References



Paumelle et fiche pour feuillure de 35 mm
Hinge and butt for rebate of 35 mm

Aluminium anodisé Argent Brossé
Brushed anodised alu silver

Inox Brossé
Brushed stainless steel

V381.12

V381.15

V506

Caractéristiques techniques

- Montage sur encoche V506 E
- Poids maximum admissible 55 kg pour 2 paumelles, largeur maximum 900 mm, pour un poids

Technical features

- To fit notch V506E
- Max load 55 kg, maximum width 900 mm, for 2 hinges please contact us for glass weighing more than 55 kg

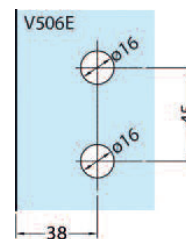
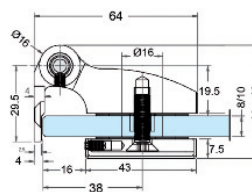
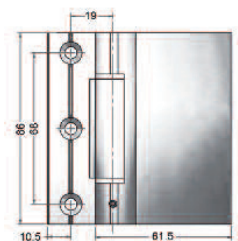

Références / References



Paumelle et fiche multi feuillure pour tous types d'huissieries
Hinge and multi rebate butt for all types of frame

Aluminium anodisé Argent Brossé
Brushed anodised alu silver

Aluminium anodisé Aninox
Brushed anodised alu.

V506.12

V506.36

ASSA ABLOY

87

Serrures et
paumelles
Locksets and
hinges

Freeline

Charnière hydraulique
Hydraulic hinge

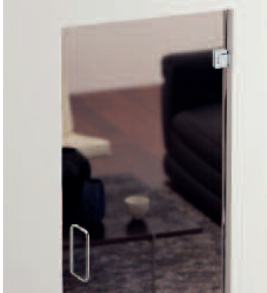

Caractéristiques techniques

- Recommandé pour porte intérieure
- Dimensions maxi de la porte 1000 x 3000 mm
- Poids maximum admissible 100 kg pour 2 charnières
- Pour verre trempé de 8, 10 et 12mm
- Blocage à 90° et retour hydraulique de 80° à 0° dans les 2 sens.
- Réglage possible du point 0 de la porte
- Vitesse de fermeture réglable
- Montage sur encoche 4961E1 pour la charnière simple 4961 et encoche 4962E pour la charnière double 4962
- Livré avec joints et vis de fixation inox

Technical features

- Recommended for inside doors
- Maximum door size 1000 x 3000 mm
- Max. load 100 kg for 2 hinges
- For 8, 10 or 12mm thick toughened glass
- Blocking at 0° and 90° with hydraulic return from 80° to 0° on both sides.
- Adjustable in the closed position
- Adjustable closing speed
- To fit notch 4961E1 for single hinge 4961 and notch 4962E for double hinge 4962
- Supplied with spacers and stainless steel fixing screws

LES + PRODUITS

Système hydraulique pour un confort et une souplesse de fermeture automatique

Solution esthétique

Vitesse de fermeture réglable

Porte 100kg maxi

Installation facile

Hydraulic system for comfort in automatic door closing

Aesthetic solution

Adjustable closing speed

For glass door 100kg

Easy installation

4961.**.OSQ

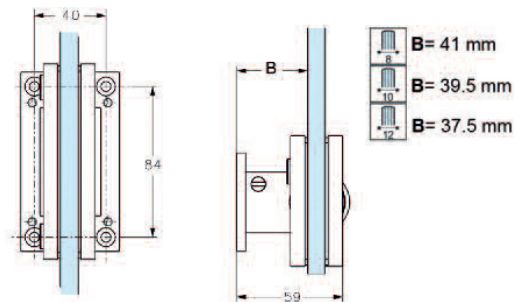
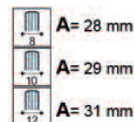
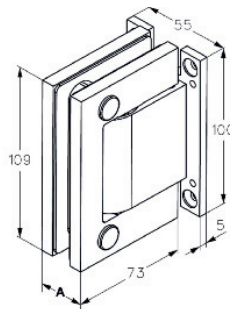
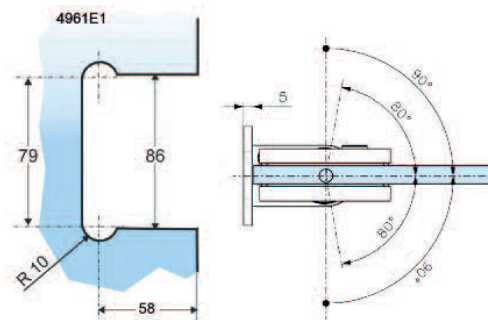

Références / References



Charnière simple hydraulique fixation murale avec 4 trous
Single hydraulic hinge wall plate with 4 fixing holes

4961.12.OSQ

4961.30.OSQ

4961.36.OSQ

4962.**.OSQ



Serrures et
paumelles
Locksets and
hinges

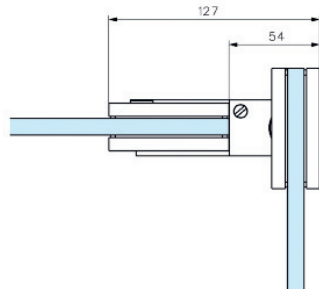
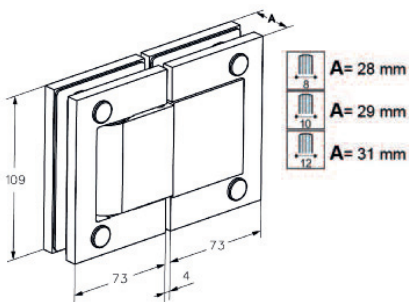
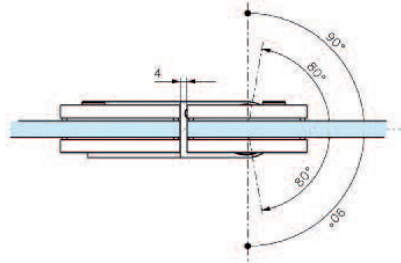
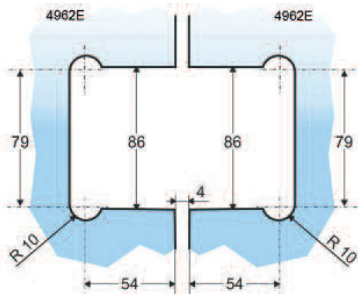

Références / References



Charnière double verre/verre à rappel hydraulique
Glass to glass hydraulic return hinge



Aluminium anodisé Argent Brossé
Brushed anodised alu silver

4962.12.OSQ



Chromé brillant
Bright chromium

4962.30.OSQ



Aluminium anodisé Aninox
Brushed anodised alu.

4962.36.OSQ

Serrures et
paumelles
*Locksets and
hinges*

Swingo



Caractéristiques techniques

- Blocage à 90°
- Pour verre trempé de 8 et 10 mm
- Poids maximum admissible 60 kg pour 2 charnières
- Largeur maximum de la porte 900 mm
- Montage sur encoche V861E
- Livrée avec joints et vis de fixation
- Réglage possible du point 0 pour le 4861

Technical features

- Blocking points at 90°
- For 8 and 10 mm thick toughened glass
- Max load 60 kg for 2 hinges
- Width of the door 900 mm
- Assembly on notch V861E
- Delivered with spacers and fixing screws

LES + PRODUITS

The + product

Design

Fermeture
automatique
de la porte

Installation facile
et discrète

Elegant design

Automatic door closing

*Easy and discreet
installation*



90

ASSA ABLOY

4861

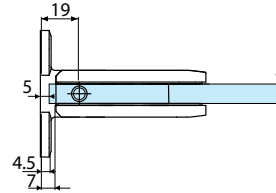
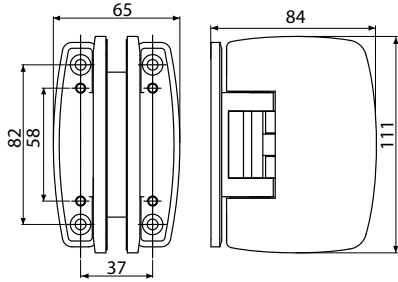
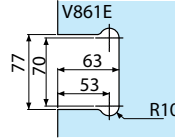

Références / References



Chromé brillant
Bright chromium



Chromé mat
Matt chromium



Effet inox
Stainless steel effect

Charnière simple mur/verre à rappel automatique
Single hinge wall/glass automatic return

4861.30.0

4861.31.0

4861.35.0

4862

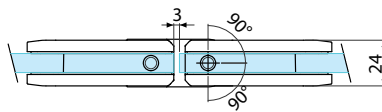
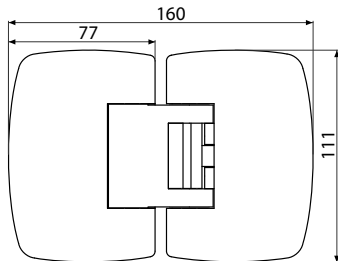
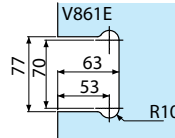

Références / References



Chromé brillant
Bright chromium



Chromé mat
Matt chromium



Effet inox
Stainless steel effect

Charnière double verre/verre à rappel automatique
Glass to glass automatic return hinge

4862.30.0

4862.31.0

4862.35.0

Serrures et
paumelles
Locksets and
hinges

Pentures *Hinges* Lumira

Caractéristiques techniques

- Pour verre trempé épaisseur 8, 10 et 12 mm
- Poids maximum admissible 75 kg
- Dimensions maxi pour portes en verre 900 x 2200 mm
- Montage sur encoche V590E
- Jeu sur la hauteur du sol au plafond H - 14 mm

Technical features

- For 8, 10 and 12 mm thick toughened glass
- Max load 75 kg
- Maximum size for glass doors 900 x 2200 mm
- Assembly on notch V590E
- Allow -14 mm on the height from ground to ceiling H

LES + PRODUITS

The + product

Idéal pour portes
lourdes ou
grand format

*Ideal for heavy and
large doors*

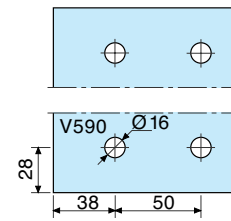
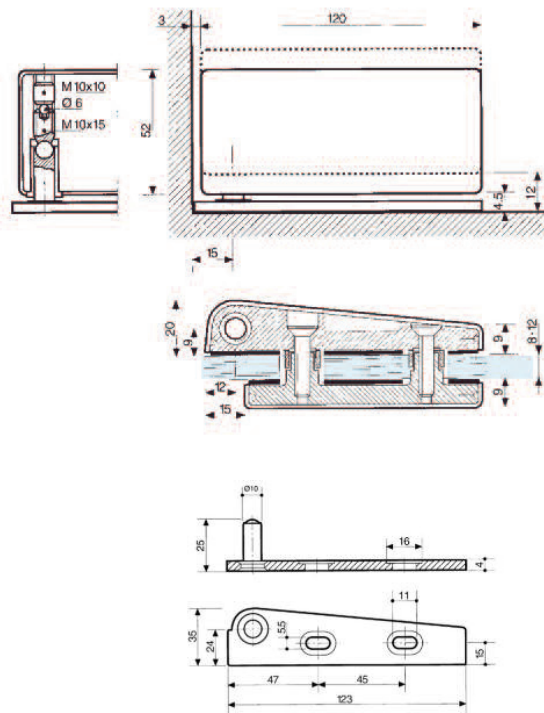

JEUX RECOMMANDÉS RECOMMENDED TOLERANCES

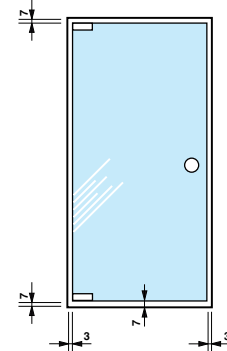

V590

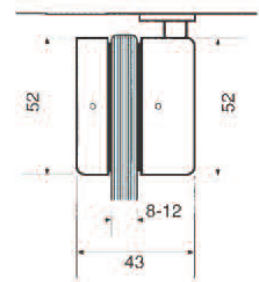

Références | References



Pentures déportées basse et
haute avec platines
*Top and bottom offset pivot
hinges with mounting plate*



V590.12

V590.36

Loqueteaux

Serrures et
paumelles
Locksets and
hinges

Caractéristiques techniques

- Ne nécessite aucune encoche, sauf réf V529 et V539
- Se pose sur le chant du verre, jeu minimum 4 mm
- Blocage du pêne en position sortie ou rentrée
- Pour verre trempé de 8, 10 et 12 mm
- Livrée avec gâche plate (2 clés pour réf 1448)

Technical features

- Requires no notch, except ref V529 and V539
- Fixing on edge of door, minimum space 4 mm
- Bolt can be blocked in the projecting or retracted position
- For 8, 10 and 12 mm thick toughened glass
- Supplied with flat keep (2 keys for ref 1448)

1445

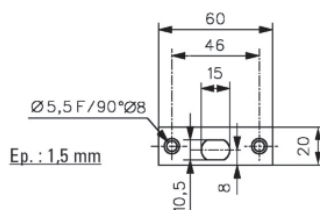
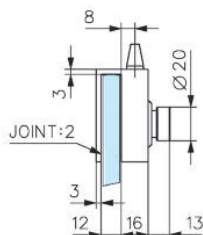
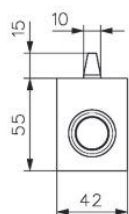

Références / References



Loqueteau à bouton
Clip on lock with notch



Laiton poli
Polished brass

1445.00.0



Chromé brillant
Bright chromium

1445.30.0



Chromé mat
Matt chromium

1445.31.0

1446

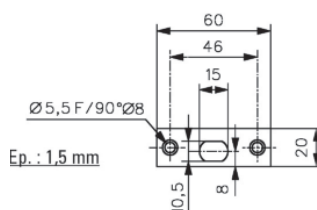
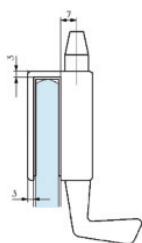
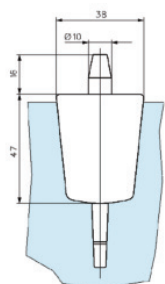

Références / References

Loqueteau à tirage
Clip on lock with
pull catch



Laiton poli PVD
Polished brass PVD

1446.05.0



Chromé brillant
Bright chromium

1446.30.0



Chromé mat
Matt chromium

1446.31.0



Effet inox
Stainless steel effect

1446.35.0



Laqué Blanc
Lacquered white RAL 9010

1446.51.0



1446.30.5

1446.31.5

Loqueteaux
Clip-on locks

1448

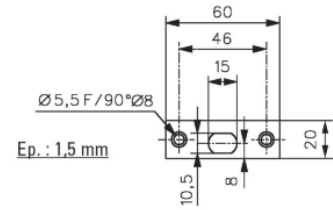
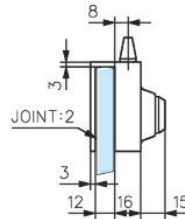
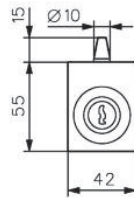

Références / References



Loqueteau à clé
Clip on lock with cylinder

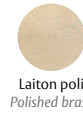

Laiton poli
Polished brass



Chromé brillant
Bright chromium



Chromé mat
Matt chromium

1448.00.0

1448.30.0

1448.31.0

LES + PRODUITS
The + product

Idéal pour portes
semi-fixe
Ideal for semi-fixed
doors

1447

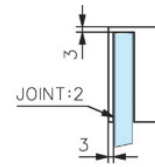
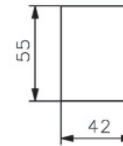

Références / References



Boîtier gâche pour loqueteaux série 1445/1448
Matching patch keep for clip on lock series 1445/1448



Laiton poli
Polished brass



Chromé brillant
Bright chromium



Chromé mat
Matt chromium

1447.00.0

1447.30.0

1447.31.0

1449

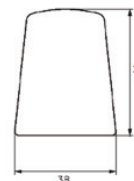
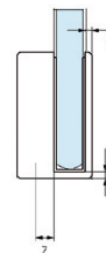

Références / References



Boîtier gâche pour
loqueteaux série 1446
Matching patch keep for
clip on lock series 1446



Chromé brillant
Bright chromium



Chromé mat
Matt chromium

1449.30.0

1449.31.0



T 01753 862224

W WINDSORGLASS.COM

A WINDSOR GLASS CO LTD,

UNIT 8,
VANSITTART ESTATE,
WINDSOR,
BERKSHIRE,
SL4 1SE



BY APPOINTMENT TO HM QUEEN ELIZABETH II
WINDSOR GLASS COMPANY LTD
GLASS MERCHANTS
ESTABLISHED 1952

WINDSOR
GLASS